

# F2

## HOBBY METAL DETECTOR

### OPERATING MANUAL

Also available  
with 11" DD coil  
(item# F2-11DD)

**Use ALKALINE  
Batteries ONLY**

**FISHER** RESEARCH  
LABS



# TABLE OF CONTENTS

---

- Assembly . . . . . 3
- Batteries . . . . . 4
- Headphone Jack . . . . . 4
- Quick-Start Demo . . . . . 5-6
- Control Panel . . . . . 7-8
  - Sensitivity . . . . . 7
  - Discrimination Control . . . . . 7
  - Pinpoint . . . . . 8
  - Notch . . . . . 8
- 4-Tone Audio System . . . . . 9
- Depth and Target Display . . . . . 10-11
  - Target Readout Table . . . . . 11
- Sensitivity Adjustment . . . . . 12
  - Electromagnetic Interference . . . . . 12
  - Severe Ground Conditions . . . . . 12
- Search Techniques . . . . . 13
  - Target Verification . . . . . 13
  - Pinpointing with motion modes . . . . . 13
- Target Pinpointing (No motion) . . . . . 14
- Treasure Hunter’s Code of Ethics . . . . . 15
- Warranty . . . . . 15
- Accessories . . . . . Back Cover

# ASSEMBLY

**Caution:** Forcing in MIDDLE STEM with CAM LOCK raised may form a burr on camlock. If this happens, remove burr with knife to allow insertion.

- 1 Position detector upright.
- 2 Rotate the LOCKING COLLAR fully in the counterclockwise direction.
- 3 Insert your finger inside the tube and make sure the INTERNAL CAM LOCK is flush with the inside of the tube.

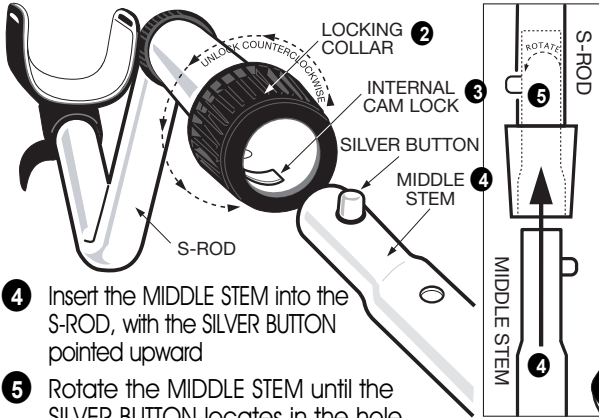

- 4 Insert the MIDDLE STEM into the S-ROD, with the SILVER BUTTON pointed upward
- 5 Rotate the MIDDLE STEM until the SILVER BUTTON locates in the hole.
- 6 Twist the LOCKING COLLAR fully in the clockwise direction until it locks.
- 7 Repeat this process on the LOWER STEM.
- 8 Using the BOLT and KNURLED KNOB, attach the SEARCHCOIL to the LOWER STEM.
- 9 Adjust the LOWER STEM to a length that lets you maintain a comfortable upright posture, with your arm relaxed at your side, and the SEARCHCOIL parallel to the ground in front of you.
- 10 Wind the CABLE securely around the STEMS, leaving slack at the bottom.
- 11 Connect CABLE PLUG to housing.

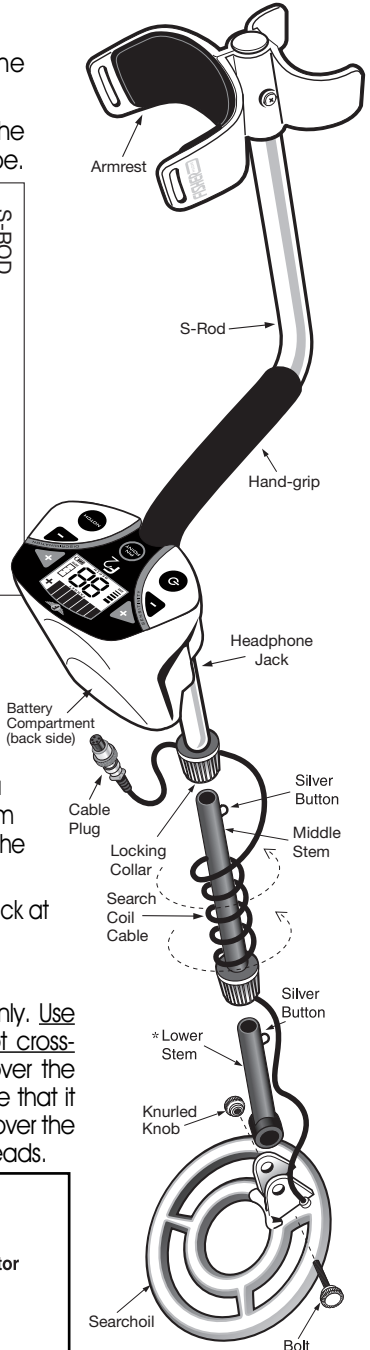

Do not twist the Cable or Plug. Turn Locking Ring only. Use minimal finger pressure to start the threads. Do not cross-thread. When the Locking Ring is fully engaged over the threaded connector, give it a firm turn to make sure that it is very tight. When the Locking Ring is fully engaged over the threaded connector, it may not cover all of the threads.

- 12 Tighten both LOCKING COLLARS.

## Armrest Adjustment

If you wish to change the position of the armrest, remove the screw and move the armrest to one of the alternate hole locations.

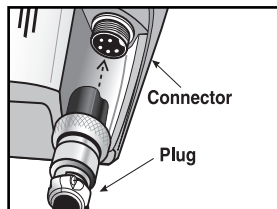

\* Note: Very tall users can purchase the optional Extended Lower Stem (TUBE5X), for extended reach.

# BATTERIES

## Two 9-Volt batteries are supplied with the F2.

The batteries have been inserted backwards in the compartment for storage during transportation. Please remove batteries, turn them around, and install correctly.

Use **ALKALINE** batteries only.

**DO NOT MIX OLD AND NEW BATTERIES.**

### To install the batteries:

- 1 Remove the battery cover by disengaging the clip at the back.  
**Do not hinge door upward; pull straight back**
- 2 Align the polarity of the batteries correctly, with the positive "+" toward the coil plug connection, as indicated by the + indicator on the housing.
- 3 Insert (2) 9-Volt **ALKALINE** batteries, with the contacts pointed inward, and press down on the back of the batteries to snap them into place.  
Some brands of batteries will require moderate force to clear the retaining tabs.
- 4 Replace the battery door.

Most metal detector problems are due to improperly installed batteries, or the use of non-alkaline or discharged batteries. **If the detector does not turn on, please check the batteries.**

### BATTERY DISPOSAL & RECYCLING

Alkaline batteries may be disposed of in a normal waste receptacle or recycled. Non-Alkaline batteries should be recycled. In the state of California all battery types must be recycled. Please refer to local municipalities for detailed disposal and recycling requirements.

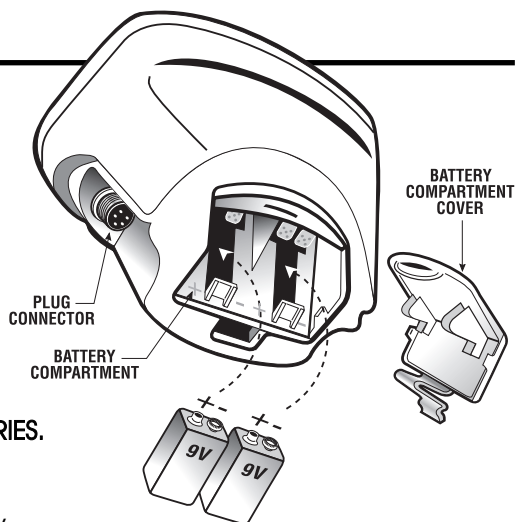

### USING HEADPHONES

Using headphones (not included) improves battery life, and prevents the sounds from annoying bystanders.

It also allows you to hear subtle changes in the sound more clearly, particularly if searching in a noisy location. For safety reasons, do not use headphones near traffic or where other dangers are present. This device is to be used with interconnecting cables/headphone cables shorter than three meters.

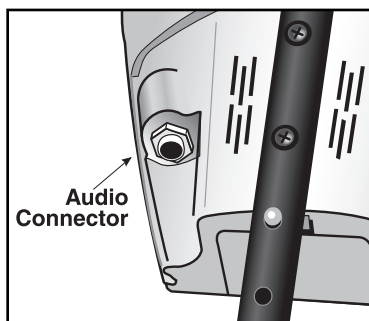

# QUICK-START DEMONSTRATION

## I. Supplies Needed

- A Nail
- A Zinc Penny (dated after 1982)
- A Quarter
- A Nickel

## II. Position the Detector

- Place the detector on a table, with the searchcoil hanging over the edge. (or better, have a friend hold the detector, with the coil off the ground).
- Keep the searchcoil away from walls, floors, and metal objects.
- Remove watches, rings and other jewelry or metal objects from hands and wrists.
- Turn off appliances or lights that cause electromagnetic interference.
- Pivot the searchcoil back toward the detector body.

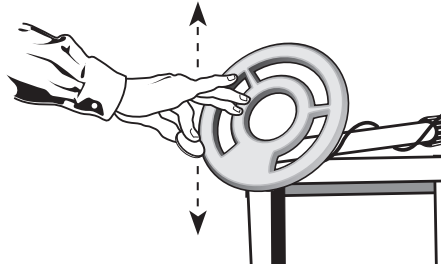

## III. Power Up

Press .

**NOTE:** Immediately after powering on, your detector's unique 10-digit serial number is displayed once on the LCD. Two digits are displayed at a time; five 2-digit numbers are displayed in sequence. This 10-digit serial number is the same serial number imprinted on the label inside the battery compartment.

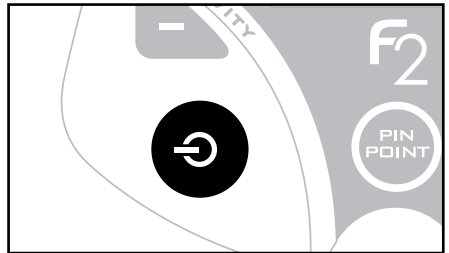

## IV. Wave each Object over the

Search Coil

- Notice a different tone for each object.

**Low Tone:** Nail  
**Low Mid Tone:** Nickel  
**Medium Tone:** Zinc Penny  
**High Tone:** Quarter

- Motion is required. Objects must be in motion over the searchcoil to be detected.

## V. Press DISCRIMINATION Twice

- The first press illuminates all target icons.
- The second press turns off the "IRON" icon.

*Quick-Start Demo continued on next page*

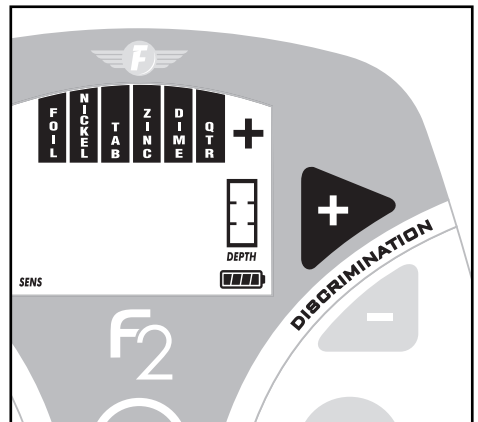

# QUICK-START DEMONSTRATION *(continued)*

## VI. Wave the Nail over the Search Coil

- The Nail will not be detected.
- The Nail has been "Discriminated Out."

## VII. Press DISCRIMINATION 5 times.

Only the Dime, Quarter and + icons will remain illuminated.

## VIII. Wave all objects over the Search Coil

The Nail, Nickel and Penny will not be detected.  
The quarter will be detected with a high tone.

## IX. • Press NOTCH • Immediately press DISCRIMINATION

- Press NOTCH again
- The "Nickel" icon is again illuminated.
- You have "Notched In" the nickel

## X. Wave the nickel over the searchcoil.

The nickel is detected.

## XI. Press and hold PINPOINT.

Hold a coin motionless over the searchcoil.

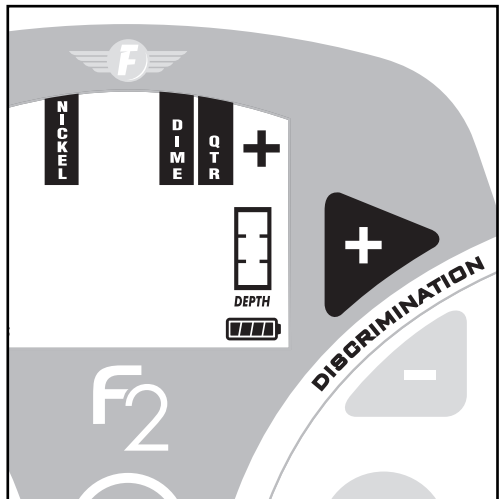
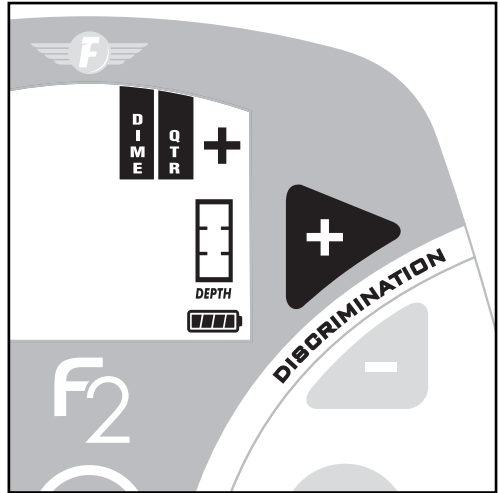

- All Metal objects are now detected.
- One monotone sound indicates the presence of any type of metal.
- Depth is indicated in inches. Move a coin toward & away from the search coin. Watch the depth indicator change.



# CONTROL PANEL

The operating controls are as follows:

## **SENSITIVITY** **AND**



These controls change the detector's sensitivity; higher settings enable detection of deeper targets. At power-up, the detector is pre-set to 75% of maximum sensitivity. At minimum, the sensitivity is 35% of maximum. With each press of the  or  touch pads, the sensitivity level is displayed on the bar graph on the left of the display. Upon reaching the minimum or maximum sensitivity setting, the detector will beep twice.

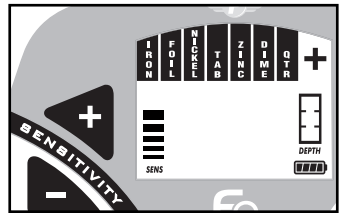

While higher levels of sensitivity enable detection of deeper targets, operation at high levels of sensitivity make the detector **more susceptible to electromagnetic interference**. Higher sensitivity settings can also lead to false signals in difficult ground conditions. Use lower sensitivity settings to suppress interference or false signals from soil minerals when necessary.





**If the detector "Chatters", reduce sensitivity.**





## **DISCRIMINATION** **AND**

Press DISCRIMINATION  or  at any time (other than immediately after pressing ) to adjust the target discrimination level.

 and  will increase or decrease the level of discrimination. Each press of the pads will cause a target icon to appear or disappear on the display. When an icon is not illuminated, the corresponding target category will be eliminated from detection. No audible tone nor target-icon will appear when the searchcoil passes by an object in a category which is not illuminated. The Dime, Qtr, and + target categories cannot be eliminated from detection.

While searching, the only target category icons visible are those indicating detected targets; no more than one is visible at a time while searching. In order to display the discrimination status, press either the DISC  or  key. The first press of either DISC  or  displays the current discrimination status (eliminated target categories are not displayed — all accepted target categories are illuminated).

This first key press does not change the discrimination status; each subsequent DISC  or  will change the discrimination setting, with icons either disappearing or reappearing.

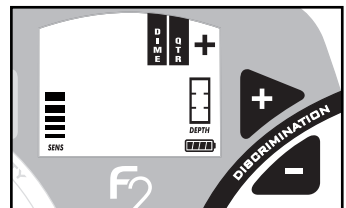

# CONTROL PANEL *(continued)*

## **PINPOINT**

Press and hold  to activate this feature

This is a static detection mode; no coil motion over the target is required to detect metal while pinpoint is depressed. This feature is most effective for pinpointing the exact location of small buried objects. Reduced sensitivity, and thus a smaller search field, can be achieved by pressing



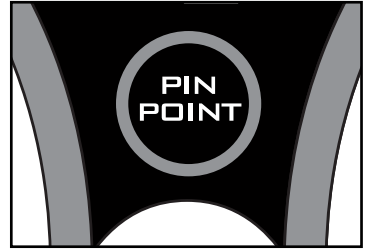

the  pad while an object is in the coil's detection field. The greatest sensitivity to large, deeply-buried objects is achieved with this mode.



## **NOTCH**

This control allows you to selectively include or exclude target categories from detection.

To use the **NOTCH** feature.

1. First press .
2. Then immediately press **DISCRIMINATION**  or .  
Each press of **DISC**  will change the status of a target category (starting with iron, from left to right). If an icon was previously illuminated, indicating inclusion, then it will disappear, indicating that it is now eliminated from detection. If an icon was previously turned off, then it will reappear, indicating inclusion.
3. Press  a second time to save your notch setting.  
**TIME-OUT:** if you do not press **NOTCH** after several seconds, the detector will beep twice and return to normal operation, without changing the notch setting.

Only one category can be notched at a time. To program multiple notches, press  again and change another target category.

You may program any combination of detected and eliminated target categories using the **DISCRIMINATION** and **NOTCH** functions.

Practice by pressing the  pad in conjunction with the **Discrimination**  and  pads; their function will quickly become obvious.





# 4-TONE AUDIO SYSTEM

While the LCD (Liquid Crystal Display) is very accurate in identifying buried objects, the user in the field does not always maintain the display screen in his field of vision. Therefore, we have incorporated an audio feedback mechanism to alert the user to the nature of buried objects. This audio feedback system first alerts the user to the presence and classification of objects, whose nature and location can be confirmed using the LCD display.

The 4-tone audio target identification system functions only in the motion modes of operation. The detector must be in the DISCRIMINATION Mode, as indicated on the display. In PINPOINT Mode, the detector will emit only a monotone sound.

The detector can sound four different tones, depending on the object detected.

## LOW TONE

Ferrous objects, such as iron and steel, will induce a low tone. The smallest gold objects can also induce a low tone.

## LOW-MID

Pull-Tabs, nickels & smaller gold

## MEDIUM TONE

Newer pennies (post-1982), larger gold objects, zinc, and small brass objects, will induce medium tones. Many recent vintage non-U.S. currencies will induce medium tones.

## HIGH TONE

Silver and copper coins, larger brass objects and older pennies (pre-1982), will induce high tones. Quarters, dimes and other precious coins fall into this category.

LOW TONE	LOW-MID TONE	MEDIUM TONE	HIGH TONE
			
Nails, Iron Objects, & Smallest Gold Objects	Pull Tabs, Nickels, & Smaller Gold	Zinc Pennies (Post 1982), Larger Gold Objects	Copper, Silver & Brass Copper Pennies (Pre 1982)

*Audio Target Identification (ATI) classifies metals into four categories.*

# DEPTH AND TARGET DISPLAY

---

## READING THE DISPLAY

The Liquid Crystal Display (LCD) shows the PROBABLE identification of the targeted metal, as well as the PROBABLE depth of the target, in inches.

The target category will illuminate where an object is best classified, and stay illuminated until another target is identified.

The detector will normally register a repeating, unchanging target identification when a buried target has been located and identified. If, upon repeated passes over the same spot, the target identification reads inconsistently, the target is probably a trash item, oxidized metal, or too deep to be classified accurately. With practice, you will learn to unearth only the more repeatable signals.

The segment identifications are highly accurate, when detecting the objects described on the label. However, if you register in a given category for an unknown buried object, you could be detecting a metallic object other than the object described on the label, but with the same metallic signature. Also, the greater the distance between the target and the coil, the less accurate the target identification.

**GOLD TARGETS** Gold objects will register on the left side of the LCD scale. Gold will register depending upon its size. The smaller the gold object, the further to the left it will register.

**Gold flakes** will register as Iron

**Small gold items** will register under Iron or Foil.

**Medium-sized gold items** will register under Nickel or Tab.

**Large gold items** will register under Tab or Zinc.

**SILVER TARGETS:** Silver objects will normally register to the right of the scale, under Dime, Qtr, or + , depending on the size of the object. The larger the object, the farther to the right it will register.

**IRON:** Ferrous objects will register on the far-left side of the target identification scale.

Objects in this category could be worthless scrap, or a more valuable iron relic.

**FOIL:** Small pieces of aluminum foil, like gum wrappers, will register here.

**NICKEL:** Nickels and most newer pull-tabs(those that stay attached to the can) will register here.

**TAB:** Pull-tabs from older beverage cans will register here. Few newer pull-tabs will also register here. Many gold rings will also register here.

**ZINC:** Newer pennies (post-1982) will register here. Many non-U.S. coins of recent vintage may also register here.

# DEPTH AND TARGET DISPLAY

**DIME:** Dimes and pre-1982 pennies will register here. Older, pre-1982, pennies are composed of copper, which has a metallic signature similar to a dime. Most copper coins will register here. Steel washers, with an outside diameter similar to a dime, may also register here.

**QTR:** Quarters, Sacagawea and "Susan B. Anthony Dollars" register here.

**+**: Half-Dollar coins and Silver Dollars register here. Very large iron objects like Sewer Lids will also register here.

**Caution:** The target indications are visual references. Many other types of metal can fall under any one of these categories. While the F2 will eliminate or indicate the presence of most common trash items, it is impossible to accurately classify ALL buried objects.

**DEPTH INDICATOR:** (in Pinpoint Mode)  
The Depth Indicator is calibrated to coin-

sized objects. It indicates the depth of the target, in inches. Large and irregularly-shaped objects will yield less reliable depth readings

When passing over an object, the depth indicator will light up and stay illuminated while an object is in the field of detection. the depth indicates the distance, in inches from the center of the searchcoil to the target.

## 2 DIGIT TARGET INDICATOR

The 2-digit target indicator, in the middle of the LCD display, provides a specific target value to help identify buried targets more accurately. With practice in the field, you will learn to associate target values with the probable identification of buried objects. The target value can vary each time the coil passes over the target, depending upon the angle of the object and the distance from the coil.

**As a starting point, refer to the table below.**

## TARGET Readout

The table below lists some common approximate target value equivalents. With experience in the field, you will recognize many types of metals by their numeric value.

TYPICAL VALUE	POSSIBLE OBJECTS
0-15	Iron
25-28	Pull-Tab Tail (broken off)
28-32	Nickel
36-42	Pull-Tab (old type)
58-62	Zinc, Penny
68-72	Dime & Wheat Cent
78-83	Quarter
86-90	Half Dollar
91-95	Silver Dollar

# SENSITIVITY ADJUSTMENT

## ELECTROMAGNETIC INTERFERENCE

Use the Sensitivity Control is to eliminate Electromagnetic Interference (EMI).

The F2 metal detector is an extremely sensitive device; the searchcoil creates its own magnetic field and acts like an antenna. If your detector beeps erratically when the searchcoil is motionless, the unit is probably detecting another electromagnetic field.

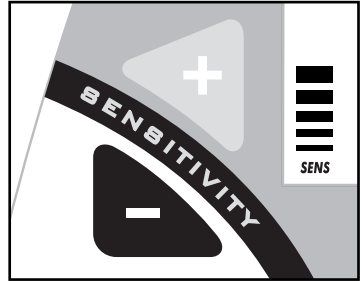

Common sources of EMI are electric power lines, both suspended and buried, motors, and household appliances like computers and microwave ovens. Some indoor electronic devices, such as dimmer switches used on household lighting, produce severe EMI and can cause the detector to beep erratically. Other metal detectors also produce their own electromagnetic fields; so if detecting with a friend, keep two metal detectors at least 20 feet apart.

If the detector beeps erratically, **REDUCE THE SENSITIVITY** by pressing the **Sensitivity**  Pad on the left of the control panel.

In most urban environments, you should be able to search without chatter from interference at the default sensitivity setting (default setting is the sensitivity level at power-up, 4 bars), or at one level reduced from default. At maximum sensitivity, the F2 will "chatter" in proximity to underground or overhead power lines, or to indoor or outdoor electrical devices. In fact, if you notice rapid chatter with the searchcoil near the ground, you may be able to trace the approximate location of the underground power lines by following the chatter.

To manage chatter, which is most likely from electrical interference:

1. **REDUCE the SENSITIVITY** until the chatter stops.
2. Try sweeping it over the ground.  
If the F2 chatters while held still, or held up in the air, it may be much quieter when sweeping over the ground.

## SEVERE GROUND CONDITIONS

A secondary use for the Sensitivity Control is to reduce false detection signals caused by severe ground conditions. While the detector contains circuitry to eliminate the signals caused by most naturally occurring ground minerals, 100% of all ground conditions cannot be anticipated. Highly magnetic soils found in mountainous and gold-prospecting locations can cause the detector to emit tones when metal objects are not present. High saline content soils and sands can sometimes cause the detector to beep when no metal target is present.

If the detector emits false, non-repeatable, signals, **REDUCE THE SENSITIVITY**.

# SEARCH TECHNIQUES (in DISC Mode)

## Target Verification

After detecting a target, do the following:

1. Walk around the target in a circle.
2. While circling the target, continue sweeping the searchcoil across the target.
3. Sweep once every 30° or 40° of the circle.

If the tone does not change and the target ID value is consistent as you circle the target, you can be highly confident of the target's identification.

If the tone or target ID changes as you circle the target, you may have multiple targets or an irregularly shaped object.

If the tone completely disappears at different angles, the target may be trash or a low-value metal.

If you are new to the hobby, dig all targets. With practice in the field, you will soon identify audible and visual target feedback with certain types of metal objects.

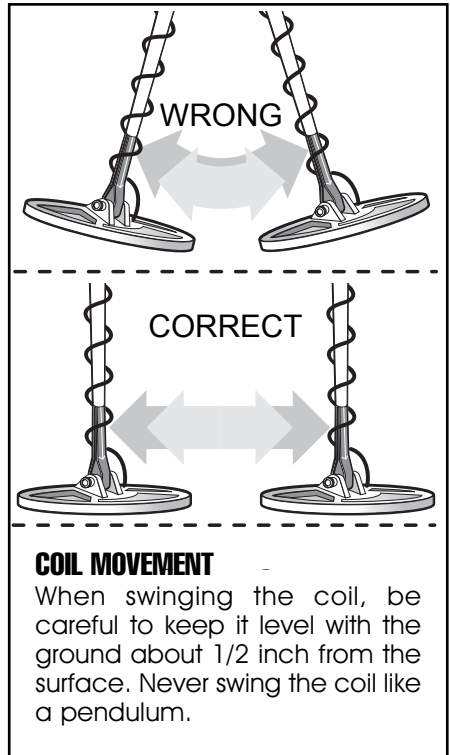

## Pinpointing in motion (not pinpoint) mode:

1. Sweep over target in narrowing side-to-side pattern
2. Take visual note of spot on ground where "beep" occurs.
3. Step 90° to the side of the target
4. Sweep coil over same area, at 90° to 1st sweep pattern.
5. This pinpoints the target location with an "X"

# TARGET PINPOINTING *(no-motion PINPOINT Mode)*

After you have identified a target using a motion mode of detection, press  to identify the target's exact location. This technique can yield more information about the target's shape and size and also find its exact location to facilitate excavation.

## Using :



1. Position the searchcoil just barely off the ground, and to the side of the target.
2. Press and hold  and raise the searchcoil about 2 inches. Lifting the searchcoil away from the ground makes the ground signal go negative, so the machine is silent.
3. Now move the searchcoil slowly across the target, and you can locate it by the sound. The target is located directly under where the sound is loudest.

## Narrow It Down:

1. To narrow the response further, position the center of the searchcoil near the center of the response pattern, but not directly over the center.
2. Release, then press and hold again  again.
3. Repeat this narrowing procedure to narrow the field of detection further.

**Note:** Depth indication is less accurate after narrowing.

## COIL DRIFT

If you keep  depressed for continuous searching, realize that drift will occur over time, causing the detector to gain or lose sensitivity. Periodic retuning of the detector is required to minimize drift; release and press  to retune.

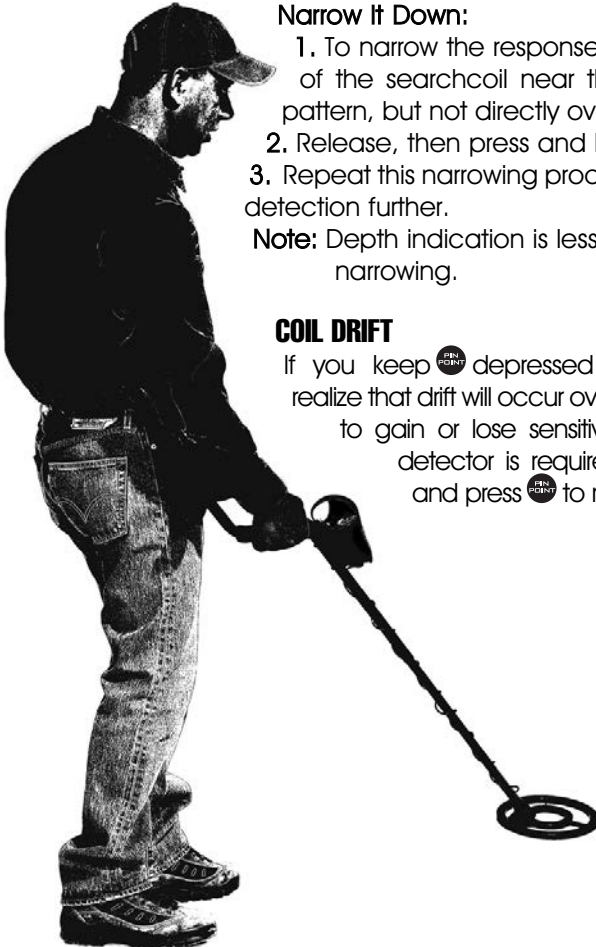

## 5-YEAR LIMITED WARRANTY

Register your warranty on-line for a chance to win a

### FREE DETECTOR.

For details, visit [www.fisherlab.com](http://www.fisherlab.com)

The F2 metal detector is warranted against defects in materials and workmanship under normal use for five years from the date of purchase to the original owner.

Damage due to neglect, accidental damage or misuse of this product is not covered under this warranty. Decisions regarding abuse or misuse of the detector are made solely at the discretion of the manufacturer.

#### **Proof of Purchase is required to make a claim under this warranty.**

Liability under this Warranty is limited to replacing or repairing, at our option, the metal detector returned, shipping cost prepaid to Fisher Labs. Shipping cost to Fisher Labs is the responsibility of the consumer.

To return your detector for service, please first contact Fisher Labs for a Return Authorization (RA) Number. Reference the RA number on your package and return the detector within 15 days of calling to:

Fisher Labs  
1465 Henry Brennan Dr.  
El Paso, TX 79936  
Phone: 915-225-0333 ext.118

Warranty coverage does not include the cost of transporting the detector back to an owner who is located outside of the United States of America.

#### **NOTE TO CUSTOMERS OUTSIDE THE U.S.A.**

This warranty may vary in other countries, check with your distributor for details. Warranty does not cover shipping costs.

According to FCC part 15.21 Changes or Modifications made to this device not expressly approved by the party responsible for compliance could void the users authority to operate this equipment.

This device complies with FCC Part 15 Subpart B Section 15.109 Class B.

## TREASURE HUNTER'S CODE OF ETHICS:

- Always check Federal, State, County and local laws before searching.
- Respect private property and do not enter private property without the owner's permission.
- Take care to refill all holes and leave no damage.
- Remove and dispose of any and all trash and litter found.
- Appreciate and protect our inheritance of natural resources, wildlife and private property.
- Act as an ambassador for the hobby, use thoughtfulness, consideration and courtesy at all times.
- Never destroy historical or archaeological treasures.
- All treasure hunters may be judged by the example you set; always conduct yourself with courtesy and consideration of others

Copyright© 2015

All rights reserved, including the right to reproduce this book, or parts thereof, in any form.

Fisher® is a registered trademark of Fisher Research Labs

[www.fisherlab.com](http://www.fisherlab.com)

**FISHER**® RESEARCH  
LABS

1465 Henry Brennan, El Paso, TX 79936 • (915) 225-0333

Made in the USA from USA and imported parts.

# ACCESSORIES

## Fisher® Padded Carry Bag

Rugged double stitched construction. Includes handy exterior pocket for extra batteries or small accessories.  
103693000C

## Fisher® Camo Pouch

Camo pouch with two inside pockets, belt included. – PCH-F

## Stereo Headphones

Use with Fisher® metal detectors. Lightweight and adjustable with true stereo sound, adjustable volume, 1/4 jack with 1/8 adaptor, 4' cable. – 9720950000

## Metal Sand Scoop

Large galvanized metal scoop with filtering holes. Strong Rubberized grip.  
SAND SCOOP

## Lesche Knife

Made from high quality heat-treated tempered steel. The ultimate digging tool. Comes with a durable sheath. 12" in length with a 7" serrated blade.  
LESCHÉ KNIFE

## Fisher® Baseball Cap

One size fits all. – FCAP

## Fisher® T-Shirt

100% cotton with Fisher® Logo. Sizes: S, M, LG, XL & XXL – FTSHIRT

## Replacement/Accessory Search Coils

11" Biaxial Standard Coil (replacement) – 11COIL-F4F

4" Concentric Accessory Coil – 4COILF

8" Concentric Accessory Coil – 8COIL-7BLKF

10" Concentric Accessory Coil – 10COILF

## Coil Covers

Specially made to protect your coil from abrasion and damage.

11" Biaxial Standard Coil Cover – COVER-11DD

4" Concentric Accessory Coil Cover – 4COVER

8" Concentric Accessory Coil Cover – 8COVER-7

10" Concentric Accessory Coil Cover – 10COVER

## Rain Cover

Neoprene rain cover specially made to protect your F2 from weather– RAINCOV-F2

## Gold Prospecting Kits

### Items Included:

10 1/2" Gold Pan  
14" Gold Pan  
Classifier  
2 – Shatterproof Vials  
Snuffer Bottle  
Black Sand Magnet  
Treasure Scoop  
Tweezers  
Magnifier  
Crevice Tool  
Rock Pick  
Instruction Booklet  
Backpack

	Gold Kit PART NUMBER: GOLDKIT1	Deluxe Kit PART NUMBER: GOLDKIT2	Hardrock Kit PART NUMBER: GOLDKIT3
	x	x	x
	x	x	x
		x	x
	x	x	x
	x	x	x
		x	x
		x	x
			x
			x
			x
	x	x	x
		x	x

FOR COMPLETE DETAILS VISIT [WWW.FISHERLAB.COM](http://WWW.FISHERLAB.COM) • 1-800-685-5050