

White's Electronics, Inc.
1011 Pleasant Valley Road
Sweet Home, OR 97386 USA

Distribution: 1-800-547-6911
Factory: 1-541-367-6121
FAX: 1-541-367-2968
Web Site: <http://www.whiteselectronics.com>

©White's Electronics, Inc.

Introduction

All White's ground canceling detectors are capable of finding gold nuggets in the ground. However, none will perform as efficiently as the line of Goldmasters created especially for nugget hunting. The new GMT is the culmination of a series of Goldmasters, refined and improved over the years. With the addition of Fast Ground Tracking the GMT is the ultimate Goldmaster.

The reason the Goldmaster stands above all other detectors in finding gold nuggets is the care taken to accommodate the particular conditions encountered while gold prospecting. Since gold is most often found in highly mineralized soil, it was necessary to design a ground balance circuit which had the range to cancel out both extremes (+) and (-) mineralization. The GMT has made it easier to achieve and monitor ground rejection by utilizing digital microprocessor software to automatically track out (eliminate) ground mineralization. In addition to automatic elimination of ground minerals, the GMT retains the manual ground balancing system perfected for its predecessor, the GM/4B. In this way, the GMT will satisfy both preferences, manual or automatic.

All of these refinements are enhanced by incorporating a new, state of the art, iron identification system. This unique development applies digital analyzing to accurately predict the probability of a target being iron and thus reduce the amount of iron trash being dug. This exclusive Iron I.D. system is presented to the user both visually on the meter at all times and audibly when desired. White's Iron I.D Probability System does not alter the depth detection of the GMT.

The GMT also retains the Variable SAT feature so popular with gold prospectors. By adjusting the speed of the SAT (self adjusting threshold) the user can minimize the affects of fast changing ground mineralization. This feature has long been an exclusive feature of White's Goldmasters.

Audio Signal Boost, engineers call this feature E.P.S. (Enhanced Signal Penetration), is retained from previous Goldmasters and provides audio amplification (gain). Signal Boost will give a louder signal on those very tiny or deep targets when needed in certain operating conditions.

The GMT is designed for use with the new 10 1/2" elliptical Twin-D searchcoil, which it is shipped with. However, it is electrically compatible with all other Goldmaster searchcoils. The GMT operates slightly below the operating frequency of previous Goldmaster models, so it can be used near those older models with minimal "crosstalk". In addition, the GMT has added a unique touch pad controlled "Grab" feature, which instantly achieves ground balance. This and a "follow the gold" feature will be described in the manual.

All this adds up to a great detector for doing what we all love best, finding gold!

Good Luck and Good Prospecting!

Jimmy "Sierra" Normandi

NOTE: Due to Acrobat PDF limitations the Introductory page is on page 29

GMT Table of Contents

Chapter 1 Assembly	2
Assembly Instructions	3
Chapter 2 Batteries	4
Standard Battery Holder	4
Using the	
Standard Battery Holder	4
Rechargeable Battery(Opt.)	5
Battery Check	5
Chapter 3 GMT Quick Start	6
Quick Start	
Instructions	7
Chapter 4 Controls	8
Gain Control/Power Off	8
Gain Adjustment	8
Gain Adjustment (cont'd)	9
Audio Signal Boost Toggle	10
Hot Rocks	11
Variable SAT Speed Control	11
VSAT Adjustment	11
Iron I.D. Trigger Adjustment	12
Threshold Control	13
Threshold Adjustment	13
Ground Balance	
Fast AutoTrac	14
Manual Ground Balance	15
Ground Balance Adjustment	15
Chapter 5 Searching	16
Pinpoint Technique	16
Headphones	17
Field Use & Tuning Tips	18
Field Use & Tuning Tips (cont'd)	20
Field Use & Tuning Tips (cont'd)	22
Chapter 6 Information	24
Proper Care	24
Service	25
Warranty	26
Warranty Transfer	27
Video and Owner Information	28

Assembly

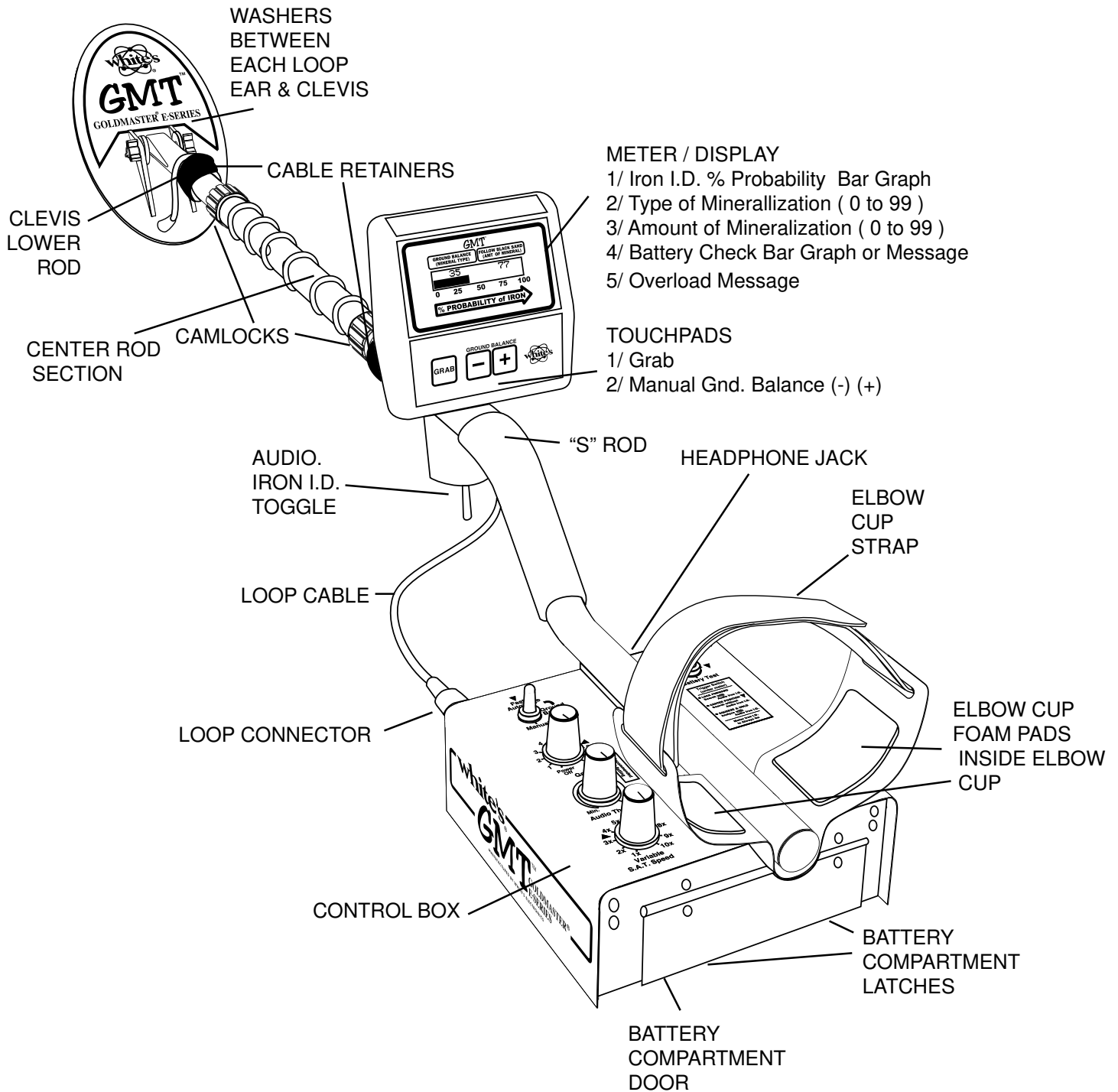

Assembly Instructions

1. Remove all parts from shipping carton and check the assembly page to make sure all parts are present.
2. Unlock "S" rod camlock and insert the reduced end of the center rod into curved "S" rod so that stainless steel spring clip buttons line up and lock into the holes in the curved "S" rod. Turn camlock to secure.
3. Fit the rubber washers between clevis/lower rod and searchcoil ears. Use only non-metallic washers, fiber bolt, and thumbnut, to secure loop to clevis/lower rod. Then insert into center rod so that stainless steel spring buttons line up and lock into one of the adjustment holes in the center rod. Turn Camlock to secure.
4. Unravel cable and wind the cable around the clevis and rod assembly, first revolution should be **OVER** the top of the rod with some slack before applying the cable retainer. This is done so that the search coil can be paddled backwards toward the rod without putting a strain on the cable. Wind cable firmly all the way to the handle toggle switch. Then plug connector into control box turn lock ring to secure. To secure cable, wrap velcro cable retainers around rod and cable, one near the searchcoil and one near the toggle switch.
5. Grip the instrument by the handle, with your arm in the elbow cup with strap secure, and sweep the coil over the floor. If the instrument fit feels uncomfortable, adjust the elbow cup by removing and repositioning the bolt/thumbnut and installing in one of the optional positions. If necessary, readjust clevis/lower rod length with the spring clip buttons so that the searchcoil can be held near the floor without requiring stooping over.
6. Adjust the elbow cup strap so that it is loose enough for you to slide your arm in and out without loosening each time you want to set the detector down. Peel and stick elbow cup foam pads on the inside of the elbow cup, one on each side.
7. Install battery as described in the next section, decal facing down, with plastic tab and steel contacts facing toward inside of battery compartment.
- 8 It should be noted at this point that the detector may not work as expected indoors due to the high degree of metals (nails, pipes, etc.) used in modern construction and the presence of electrical interference. It is best to tune and practice out-of-doors to ensure stable, predictable results.

Batteries

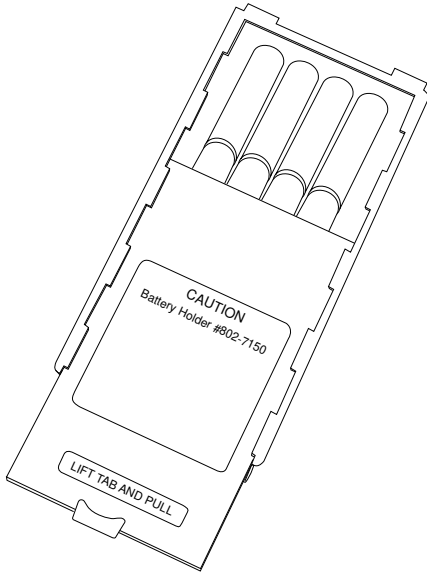

Standard Battery Holder

1. The standard battery holder holds eight “AA” cell batteries. Alkalines are recommended for use with this model. During normal searching conditions you can expect about 40 or more hours of hunting time from one set of eight alkaline batteries.
2. Non-alkaline batteries can be used in this holder. When non-alkalines or rechargeable “AA” cells are used, detecting time (before replacement/recharge) may be reduced to about 30-35 hours.
3. Once the batteries become weak, the beep over metal targets will be reduced in volume. Shortly thereafter, the instrument will no longer respond to metals. The Audio-Boost toggle has a battery test position in the spring-loaded down position. Battery level is noted on meter.
4. The battery compartment opens by gently pulling down on the front of each of the two latches (on the bottom of the control box) releasing the catch and hinging open the door.

Using the Standard Battery Holder

1. Slide open the battery holder lid (decal side of battery holder) by applying gentle upward pressure on the tab of the door so that it unlocks. Slide the door away from the battery box exposing the cell positions.

2. Remove any old cells from the holder. Note the (+) and (-) positions of each cell and the (+) and (-) for each position marked inside the cell tray. Install new “AA” cells **noting carefully the correct (+) and (-) positions.**

If the cells are installed incorrectly, the detector may require service by an Authorized Service Center.

3. Slide the door closed so that it snaps securely.
4. Insert the battery holder into the detector so that the decal is facing down, with the battery holder door tab and metal contact points facing toward the inside of the battery compartment.

Close the battery compartment door and secure the two latches on the bottom of the case. Hook the front of each latch first, then press down on the rear.

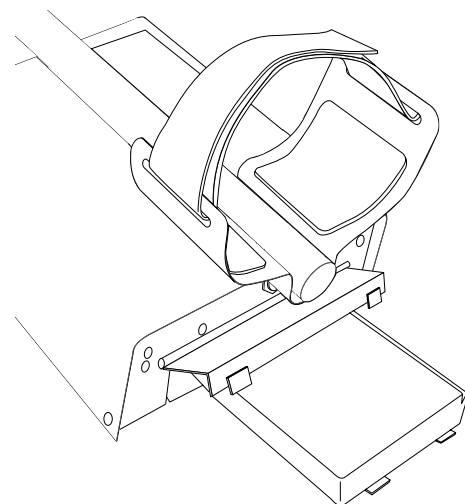

Rechargeable Battery(Opt.)

A rechargeable battery system is not standard equipment with your GMT, however, high quality systems are available.

White's rechargeable battery #802-5211, and charger #509-0022 are recommended and offer quick charge and overnight charge options.

Rechargeable batteries deliver fairly constant voltage until they're nearly dead. If you use them until they are dead, they will deteriorate more quickly than if you only use them till their voltage starts to drop significantly. Therefore, rechargeables should be taken out of service and recharged as soon as you notice the battery life starting to fall substantially below the bargraph position that corresponds to fully charged batteries.

The White's Rechargeable Nicad battery will not provide the same amount of continuous use as a full set of Alkaline batteries.

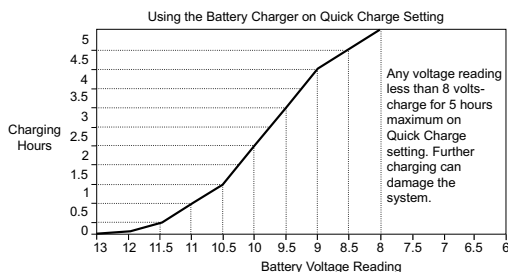
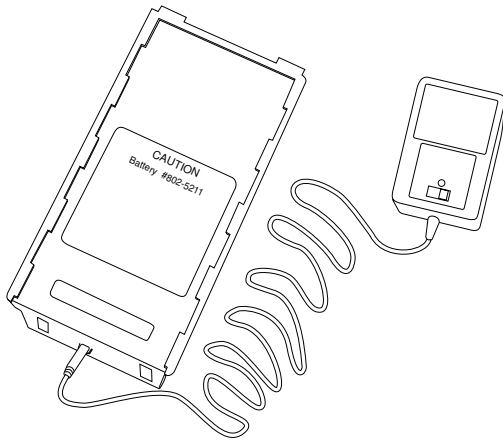

Battery Check

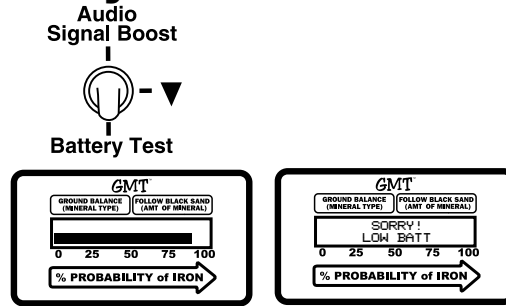

When the Battery Test toggle is pressed downward, battery condition is indicated on a bargraph on the LCD display, and by audio pitch. If the batteries are not fresh, audio loudness on big targets will not be as great, but there will be no loss of sensitivity or performance. Since Nicads and Alkalines die at different voltages, it is not possible to have a Low Bat & Bat OK indication, however the bargraph fills to the right on a fully charged battery pack. As the battery life drops you will note the bargraph diminish. When the bargraph gets close to the left it is time to replace or recharge. At this point the bargraph changes to a message, "SORRY! LOW BATT". Typical battery life will be in the neighborhood of 40 hours or more.

Non-rechargeable batteries will start to drop in voltage as soon as they are put into use and then slowly diminish in voltage till they die. The Nicad rechargeable battery pack, however, will diminish voltage very slowly, in somewhat of a flat line and then when they begin to lose their charge, the voltage will drop like a rock. Headphone use prolongs all battery life. Battery life will vary a great deal with temperature, number of target signals, battery type, brand, and shelf life. Non-rechargeable batteries may be used until the display indicates "dead battery", or the audio loudness on large targets is diminished more than you like. When traveling far from home it is always a good idea to carry 8 extra penlight alkaline batteries with you as well as an extra empty battery holder.

GMT Quick Start

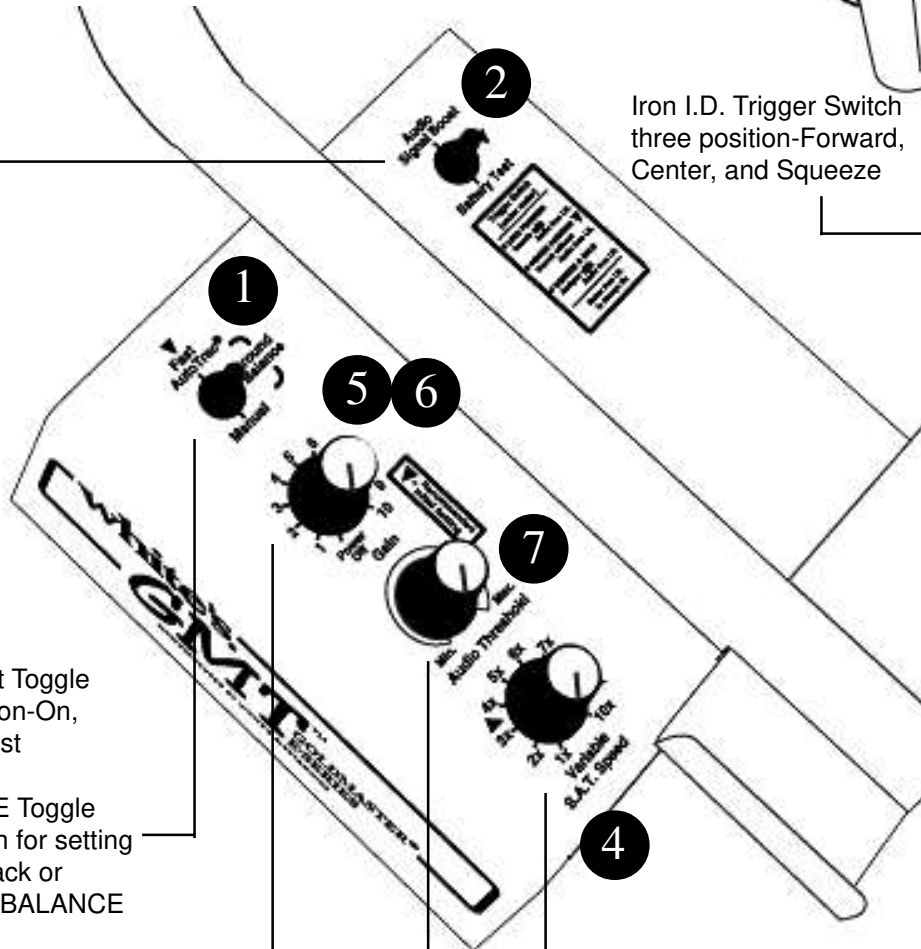
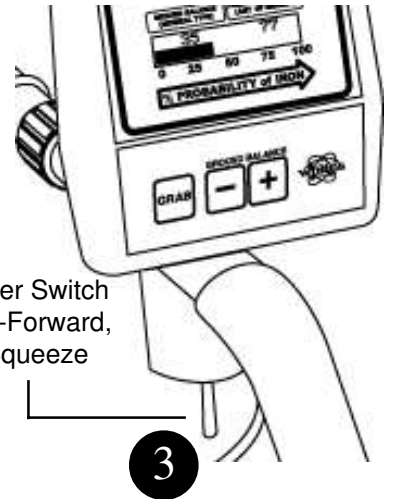

Iron I.D. Trigger Switch
three position-Forward,
Center, and Squeeze

Audio Signal Boost Toggle
Switch-three position-On,
Off, and Battery Test

GROUND BALANCE Toggle
Two position switch for setting
either Fast AutoTrack or
Manual GROUND BALANCE

GAIN Control
For adjusting signal
strength coming from ground,
targets, and electrical interference

Audio THRESHOLD
Control that establishes
the sound level of the
background "hum"

Variable Self Adjusting Threshold
Speed Control (VSAT) for adjusting
the speed at which the THRESHOLD "hum" recovers
from the affects of changes in ground mineralization.

Quick Start Instructions

With the GMT properly assembled and the batteries installed, follow the instructions below to start finding those nuggets!

- 1 Set the **Ground Balance Toggle** to the Fast Autotrac position. "▼"
- 2 Set the **Audio Signal Boost** to the center (OFF) position. "▼"
- 3 Set the **IRON I.D. toggle** (under the hand grip) to the center (Audio Iron I.D. OFF) position.
- 4 Set the **Variable SAT Speed** between the 3x and 4x position. "▼"
- 5 Turn the **GAIN** control clockwise until the power clicks "ON".
- 6 While holding the detector with the search coil in the air, rotate the **GAIN** control clockwise to a point between the 7 & 8 position. "▼"
- 7 Turn the **THRESHOLD** control fully counterclockwise, then turn it clockwise until you hear a soft threshold "hum".
- 8 Lower the search coil to the ground, then "pump" the coil up and down 2"-4" a couple of times and **Fast AutoTrac** will automatically balance or track out the ground mineralization.
- 9 Start **swinging the search coil** in wide sweeps that overlap each other.
- 10 If you experience **false signals or constant beeping or popping**, turn the **GAIN** down a bit. You may notice a slight fluctuation in the **THRESHOLD** "hum" as the GMT tracks out the ground mineralization. Also, if the meter and audio indicate "Bad Ground" turn the **GAIN** down till overload goes away.

* SPECIAL NOTICE

If you attempt to demonstrate or test the GMT by waving targets in the air in front of the search coil, it is **ESSENTIAL** to have the **GROUND BALANCE** toggle in the **MANUAL** position, **NOT FAST AUTO TRAC**

This is necessary, for when the GMT is in the **FAST AUTOTRAC** position, the search coil must *SEE* ground while it is passing over the target or it will think that the target *IS* ground and will attempt to track it out. This is the case whether you are demonstrating with or without Iron ID.

You may, however, demonstrate the fast ground balancing feature of **FAST AUTOTRAC** or **GRAB** by waving or pumping a mineralized rock in the air in front of the search coil.

Thus, testing the GMT with targets while in **FAST AUTOTRAC** must be done in or on the ground.

Controls

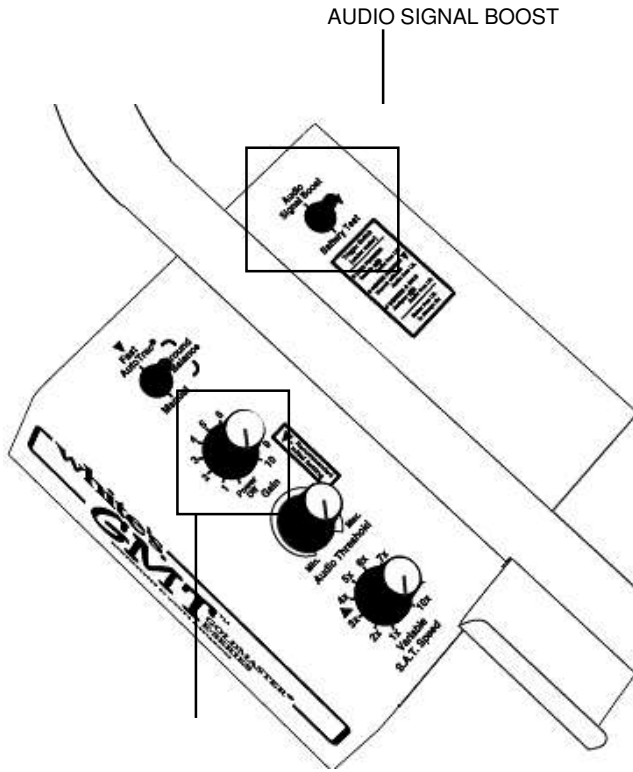

Gain Control/Power Off

With the GAIN control, you increase the signal strength coming from the ground. You might expect increased signal strength to always find more nuggets at greater depths. However, high ground mineralization will "bounce" the signal back and mask good targets. It is therefore necessary to ADJUST the GAIN to give you the maximum allowable GAIN without masking targets or overloading the circuit and at the same time allowing you to operate the detector with a constant threshold hum so that faint signals can be detected.

This is where the new GMT can help you out. When ground mineralization is too high for the current GAIN control setting, the display flashes "**BAD GROUND-REDUCE GAIN**" along with an audible "squawk". Reduce the GAIN till the overload warning ceases. On occasion, while searching, you might go over a very large or very shallow target. The message on the LCD display will read "**METAL TOO CLOSE LIFT SEARCHCOIL**". All such targets should be checked but the GMT will self correct after the message and you can continue to search as normal.

GROUND MINERALIZATION TOO HIGH MESSAGE

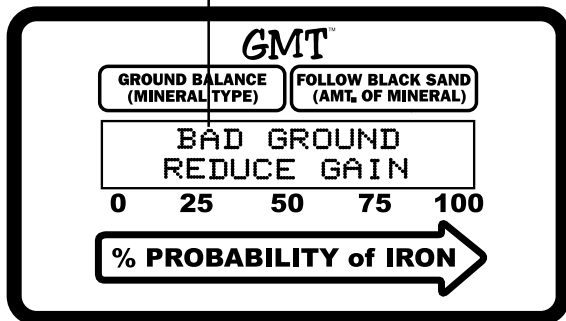

LARGE OR SHALLOW TARGET MESSAGE

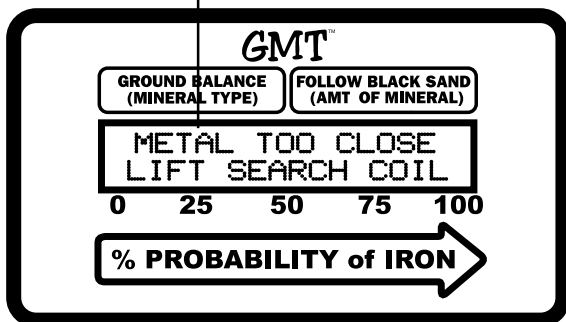

Gain Adjustment

1. The GAIN control knob turns the GMT ON and OFF and controls the GAIN. Starting from the POWER OFF position and going clockwise, the power is turned ON and the dial increases the GAIN from a minimum level of "1" to a maximum level of "10". Set the control to the "Initial Setting Triangle" (between level 7& 8). While performing this adjustment, make sure that the AUDIO SIGNAL BOOST toggle is in the OFF position.
2. Although the setting of (7-8) gives more than ample GAIN, if the ground mineralization is low enough, you might attempt to raise the GAIN above this level toward 10. If, of course, "BAD GROUND

Gain Adjustment (cont'd)

"REDUCE GAIN" message is flashed, you must heed it and reduce the GAIN rather than raise it.

3. The object of increasing the GAIN is to get the maximum available depth from the detector WITHOUT causing the "BAD GROUND" message to appear, which indicates an overload of the circuit.

4. In addition, any increase in GAIN adjustment should NOT BE at the expense of maintaining a smooth and constant THRESHOLD "hum". False signals, beeps and bops from bits of mineralization, erratic behavior, and lapses in THRESHOLD all can be the result of running with too much GAIN.

5. The use of the VSAT (variable self-adjusting threshold) control will also help to maintain a smooth THRESHOLD "hum" and will be covered in a later section.

6. While using a steady slow search coil sweep speed, advance the control towards "10" while maintaining a quiet smooth background THRESHOLD "hum". If the "BAD GROUND-REDUCE GAIN" alert keeps popping up on the display or if ground noises are still a problem reduce GAIN.

7. The IRON ID capability of the GMT also functions more accurately when the GAIN is set at a level which allows for smooth operation. Too much GAIN can cause bad ground to distort the proper identification of iron and non-iron targets.

In addition, just as a slow, broad search-coil speed will maintain smooth threshold, it will also allow the search-coil to get clear off of the target with each pass, thus insuring that the GMT "sees" ground as well as target. This is essential for the accurate operation of % of Iron Probability ID.

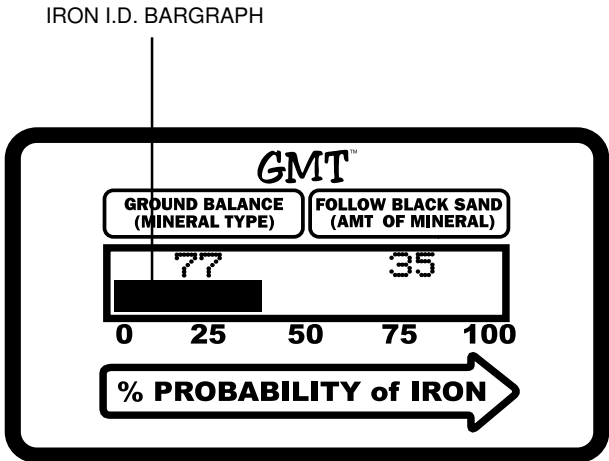
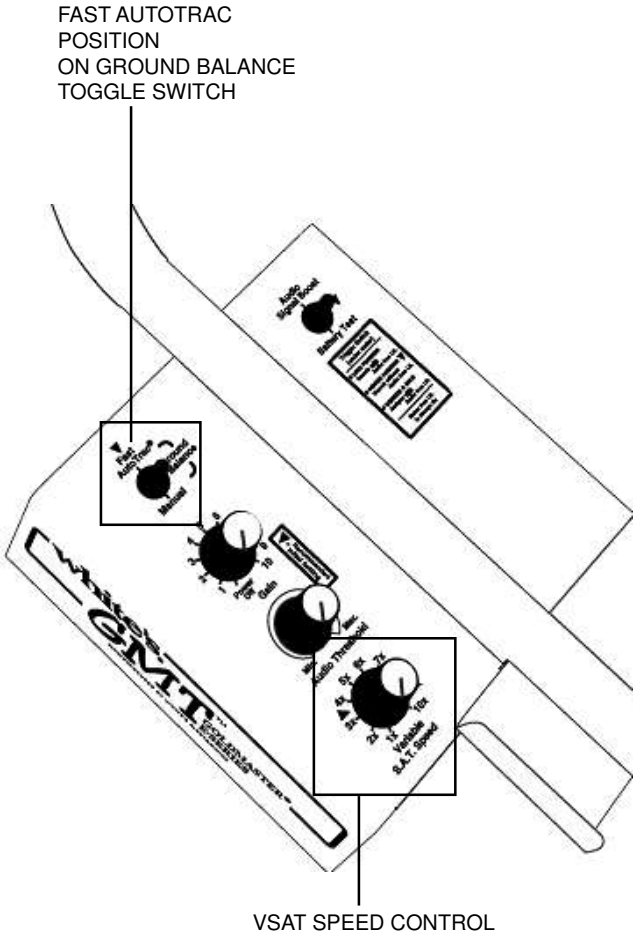

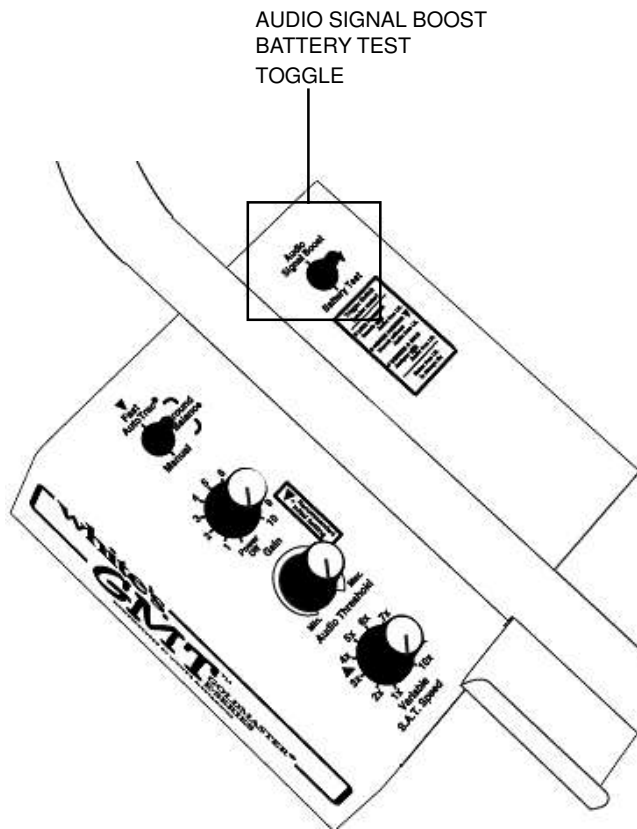

Audio Signal Boost Toggle

The AUDIO SIGNAL BOOST toggle switch boosts the sound (makes it louder) to help "hear" very deep or small nuggets. AUDIO SIGNAL BOOST only amplifies the sound AFTER processing thus it does not cause signal overload. AUDIO SIGNAL BOOST increases the chance of finding those tiny flakes embedded in the cracks of bedrock and the deeper, smaller targets to be found in dry washes and tailings in the desert.

The center position or Initial Setting position provides NO AUDIO SIGNAL BOOST. The FORWARD position provides a 4X boost in the loudness of the audio signal. The PULLED or spring loaded position is used for BATTERY CHECK.

AUDIO SIGNAL BOOST is normally used on a temporary or as-needed basis. Since it will also boost the loudness of the background Threshold "hum", it could mask other signals if used continuously. If you are in an area that would benefit from a continuous AUDIO SIGNAL BOOST, an adjustment of the Threshold setting may be required.

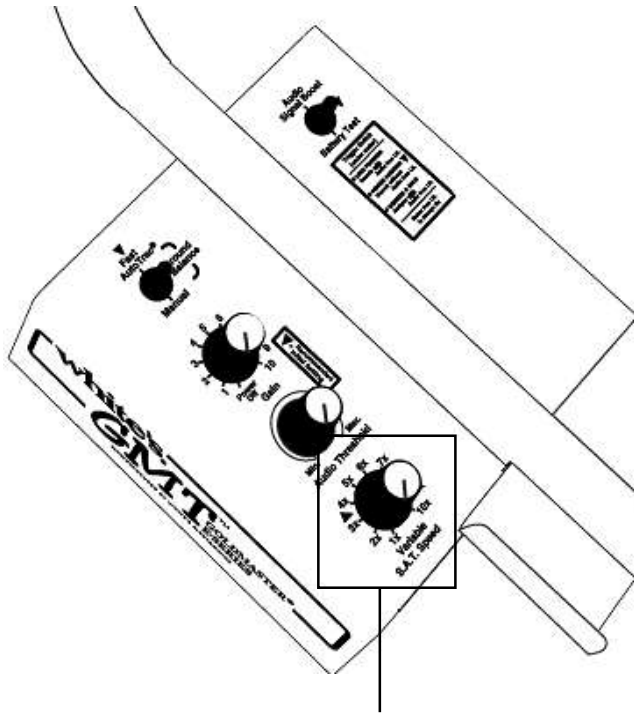

VARIABLE SELF
ADJUSTING SPEED
CONTROL (VSAT)

Hot Rocks

Hot rocks are Mineralized Rocks.

They can be heard because they are different in mineralization than the surrounding matrix or body of ground. Negative hot rocks, such as magnetite, tend to give a "boing" sound when the searchcoil is passed over them. The greater the difference between them and the ground, the louder the "boing". Positive hot rocks, such as maghemite tend to sound just like any other metal target, such as a nugget and can give a zip-zip sound. Positive hot rocks will test any prospectors patience. The GMT will reduce the effect and help to identify many hot rocks. (more on page 18)

Variable SAT Speed Control

The **Variable SAT** (Self Adjusting Threshold) **Speed** control knob adjusts the speed that the GMT recovers its threshold "hum" when the search-coil passes over changes in mineralization. Changes in mineralization can cause a rise or fall in the "hum". This can disrupt the smoothness of the threshold and thus obscure or hide the signal from a target. A slow, wide sweeping search coil swing gives the GMT enough ground sampling to maintain the **THRESHOLD** "hum". This steady "hum" helps you concentrate on the "zip-zip" sound of a metal target.

VSAT Adjustment

The Initial Setting Triangle is set between **3x** and **4x** on the control knob, appropriate for 80% of hunting locations. When you encounter fast changes in ground mineralization or deeper, larger "hot rocks", you may either get "false signals." (positive ground) or lapses in the **THRESHOLD** "hum" (negative ground). Increasing the V-SAT control setting to speed up the auto adjustment of the **THRESHOLD** "hum" will reduce this interference. At the same time, you should slow down your "sweep" speed to help SAT do its job to maintain a smooth threshold.

Remember, overall depth will be diminished with a faster V-SAT speed, but if the ground is too noisy to separate a good target from a false signal, it is better to operate with a little more V-SAT speed than to lose a target altogether. This is the same logic that was used in describing the **GAIN** control. Lowering the gain will reduce overall depth, but by doing so you can also improve your performance and find more nuggets in the long run. For best results, set your V-SAT speed **JUST** high enough to cancel out false signals from ground mineralization and set the **GAIN** control **JUST** high enough to maintain maximum depth without having false or erratic behavior. **GAIN & SAT** are like **SALT & PEPPER**. With the right balance the soup tastes just right.

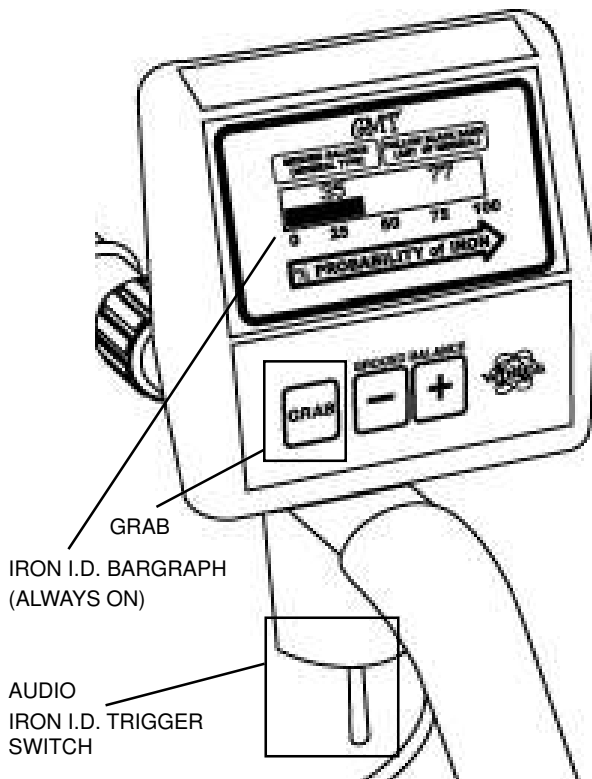

Iron I.D. Tips & Facts

1. In extreme ground conditions where Iron I.D. might not be practical, it makes more sense to dig everything. The more intense the iron trash, the more you will have to decide how your time is better spent.
2. Use a test nugget or piece of lead IN THE GROUND to get familiar with the Iron I.D.
3. The GMT Iron I.D. system is the only system that does NOT affect target depth. Ordinary coin discriminator systems can reject gold and reduce depth in bad ground.
4. Flat pieces of iron, especially with a hole, like washers often are not recognized as iron and you will probably have to dig these targets.
5. Once in a while you may get a "grunt" on a nugget especially if it is near a hot rock or iron.
6. In the Target Analysis Mode (trigger squeezed) if you sweep your coil at normal speed across a negative hot rock, you will usually get a double beep with no sound in the middle. When you slow down your sweep, the sound from the negative hot rock will rapidly weaken and then vanish entirely.

Iron I.D. Trigger Adjustment

1. (Trigger Center - Iron I.D."GRUNT" OFF)
With the trigger in the center position, the GMT operates like any other Goldmaster. It responds with a "zip-zip" sound on ALL metal targets.

2. (Trigger Forward - Iron I.D."GRUNT" ON)
IRON I.D. information is obtained by using the trigger switch under the display pod. Locking the trigger forward adds sound to the IRON I.D. system. Now when the search coil passes over an iron target, a "GRUNT" sound is added at the tail end of the normal metal target zip-zip sound. The alert "GRUNT" is triggered when the % probability of the target being IRON reaches 85% to 95%. The trigger locked forward for audio alert does not change any function of the system, it just adds sound. ALL targets will be heard with NO LOSS OF DEPTH.

3. (Trigger Squeezed - Iron I.D."GRUNT" ON)
While the trigger is squeezed, the GMT IRON I.D. system performs a very unique function. Normal tracking STOPS and IRON I.D. adds each successive pass to its memory bank. Unique to the GMT, we call this feature "TARGET ANALYSIS". Since tracking stops during this process with the trigger squeezed, this analyzer cannot be utilized while searching. It is only used to "TEST" a suspected IRON target. It is also important to make long enough passes over the target to include the ground in the search field. This allows the detector software to perform an accurate analysis. The sweep should be wide enough for the coil to completely leave the target. 1 1/2 to 2 feet is adequate for a small shallow target, wider for deeper, larger targets. This is DIFFERENT from most other metal detectors you may be accustomed to, which use a conventional discriminator to attempt to identify iron. The main thing is not to hover or dawdle over a target while analyzing. As with the "locked forward position", the "squeezed" position also functions while in MANUAL Ground Balance.

NOTE* THE VISUAL IRON I.D. SYSTEM IS OPERATING IN ALL THREE TRIGGER POSITIONS. The % of Iron Probability is indicated on the display by a left to right bar graph. This system is totally independent of the Audio Alert System.

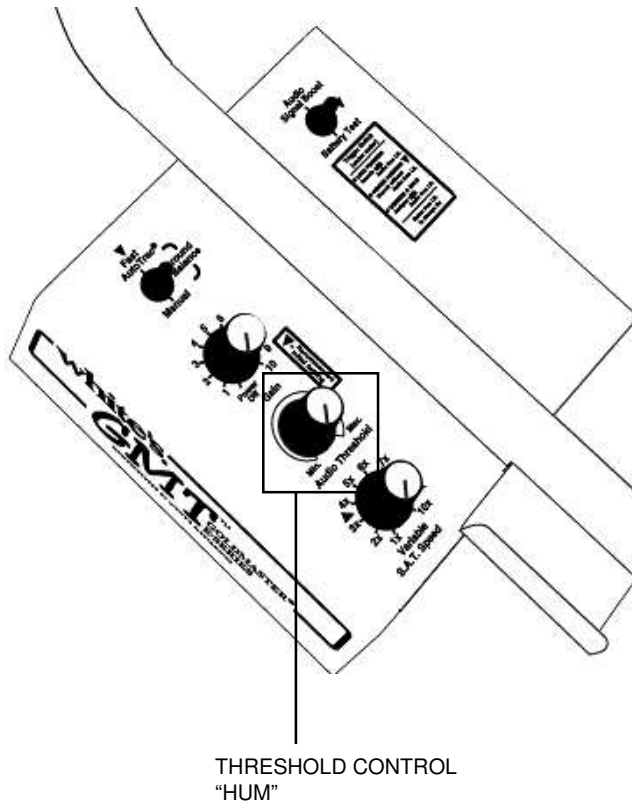

Threshold Control

The THRESHOLD control sets the loudness of the background "hum". This background "hum" must be maintained at ALL times when searching. In order to hear the tiniest and deepest targets the THRESHOLD "hum" should be set at the faintest audible level. It can be slightly scratchy, chattery or static like but it must be constant so as to not miss that small nugget in a silent spot. At this point, we can't recommend too highly the advantage of using HEADPHONES in your prospecting. With HEADPHONES you can lower THRESHOLD "hum" levels, you will hear the faintest of target signals while cancelling out environmental background noise and improve concentration.

Threshold Adjustment

The GMT has an improved microprocessor driven THRESHOLD control that is adjusted with a single turn. It does not, therefore, require a 10 turn pot for precise adjustment. Digital software provides much higher resolution, thus you can set the "hum" faster and more accurately. Set the knob all the way to the left or counterclockwise and then rotate it clockwise until the faintest audible level of "hum" is attained. If the "hum" disappears for any reason (other than bumping the control) you may be either swinging the coil too fast or your GAIN control is set too high.

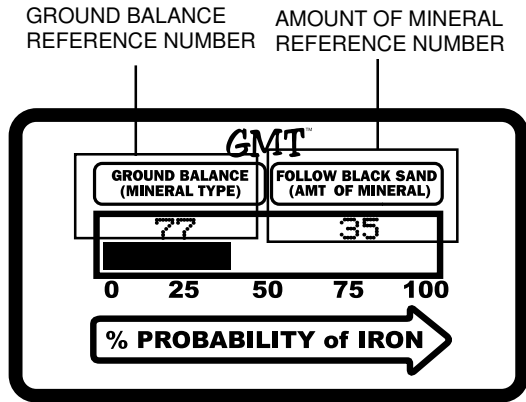
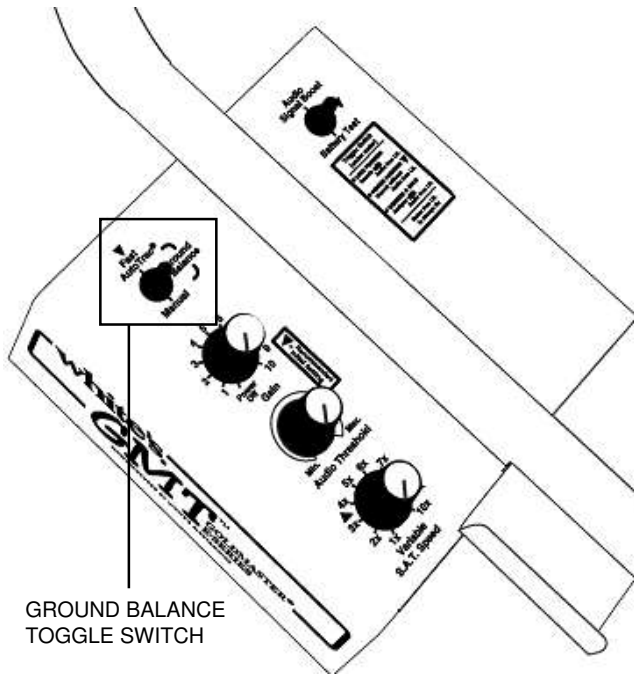

The GMT has an exclusive new digital system that records the AMOUNT of mineral in the ground. A reference number in the upper right portion of the display shows this value. The number grows as the coil is pumped up and down over concentrations of black sand. As most electronic prospectors have always known, gold usually follows black sand. So with the new GMT you can avoid the problems that varying TYPES of ground mineralization cause by tracking out the mineralization, but at the same time use the AMOUNT of magnetic effect in black sand to locate concentrations of mineralization where gold might concentrate. This would be a way to follow a stream bed for black sand or locate hot spots to use a dry washer in the desert.

Ground Balance Fast Auto Trac

Gold is usually found in mineralized ground. To make it easier to track out the mineralized ground, the GMT has an automatic ground balance capability called FAST AUTOTRAC. Set the GROUND BALANCE toggle switch in the Initial Setting or UP position. The default GROUND BALANCE reference value of 77 (ferrite) will show in the upper LEFT portion of the display. The number represents the TYPE of mineralization in the ground, higher numbers for negative ground (black sand and magnetite) and lower numbers for positive ground (maghemite and alkalai soil). Start your search by swinging the searchcoil in wide sweeps, overlapping the search area as you go. You may notice that the GROUND BALANCE reference value will be changing as the GMT automatically tracks out the mineralization. However, the reference number may stay the same because the display numbers only go from 0-99 while the tracking system itself has a resolution of 1 part in 4,000.

An added feature for GROUND BALANCE calibration is the GRAB PAD. In both MANUAL and FAST AUTO TRACK mode you can quickly reset GROUND BALANCE by pressing and holding the GRAB PAD and pumping the searchcoil up and down ONCE. The microprocessor controlled circuitry will instantly jump to GROUND BALANCE. This feature is extremely handy when you have AUTOTRACKED a HOT ROCK and want to get searching again. In MANUAL mode, the GRAB PAD can give you a head start on using the plus (+) and minus (-) pads for your initial GROUND BALANCE calibration. While searching in MANUAL mode, pressing and releasing the GRAB PAD updates the manual ground balance setting instantaneously (you may fine tune with the (+) touch pad)



Ground Balance Adjustment

When you turn the GMT on, The GROUND BALANCE reference number in the upper left portion of the display shows a default value of 77 (approximate level reading for a ferrite sample). After performing the "pumping" calibration described below, this reference number will be higher or lower depending on the mineralization of the ground below. Higher numbers for negative ground (usually rich in black sand and magnetite) and lower numbers for positive ground (usually in the form of maghemite or alkaline soil.) Once ground balance is achieved in the Manual mode, the number value will remain the same. It will only change if the pads are adjusted.

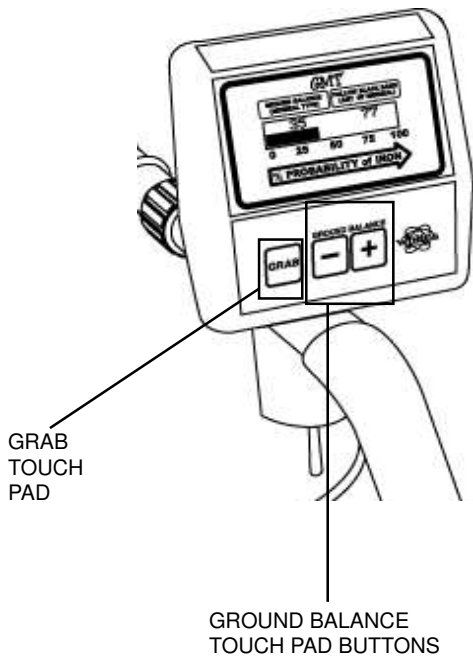

"Manual" Ground Balance

For ultimate control in detecting small nuggets in areas where ground mineralization is fairly uniform you may want to try to GROUND BALANCE manually. The "pumping" adjustment procedure in the following paragraphs describes how to achieve manual ground balance for a particular area by using the (-) and (+) touch pads. Many professionals manually set GROUND BALANCE so that a slight increase in sound is heard when "pumped" toward the ground. This technique makes the very tiniest nuggets (flakes of gold) visible to the detector. You may have to return to "perfect" GROUND BALANCE (where there is no change in the sound of threshold when the search coil is pumped up and down) if small red hot rocks (positive mineralization) become a problem in the search area.

The new GMT introduces digital microprocessor control with a much higher 4000:1 resolution for manually adjusting GROUND BALANCE. Each tap (fine adjustment) of the plus (+) or minus (-) pads on the display pod is equal to 1/4000 of the total range. To quickly make a large change (coarse adjustment) in the GROUND BALANCE value, just touch and hold the pad.

To manually set GROUND BALANCE on the GMT, set the upper left GROUND BALANCE toggle switch to MANUAL and "pump" the searchcoil up and down about 2-4 inches above the ground in the area you are going to search. If the THRESHOLD "hum" DECREASES or dies out as the searchcoil approaches the ground, push or "tap" the plus (+) button on the touch pad until the downstroke motion of the searchcoil causes no DECREASE in the loudness of the THRESHOLD "hum". Think of it as a ground volume control. If the sound gets quiet as the coil approaches the ground, give it more volume (+).

On the other hand if the THRESHOLD "hum" INCREASES as the searchcoil approaches the ground, push or "tap" the minus (-) button on the touchpad until the downstroke motion of the searchcoil causes no INCREASE in the loudness of the THRESHOLD "hum". Again think of it as a ground volume control. If the sound gets loud as the coil approaches the ground, turn it down, press (-).

More negative mineral is corrected with the (+) pad and more positive mineral is corrected with the (-) pad. No change or a constant threshold when the coil is pumped up or down represents perfect ground balance. Slight increase in sound on the down push is preferred by most prospectors in the absence of tiny hot rocks.

Searching

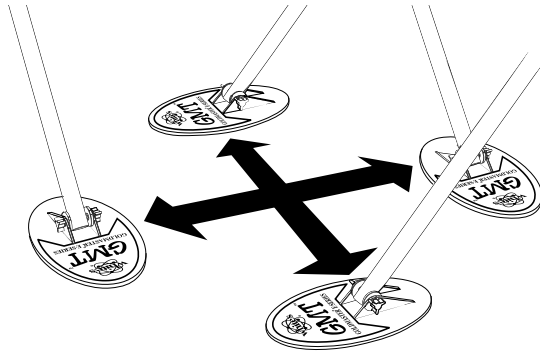

Pinpoint Technique

Due to the wide scan nature of elliptical searchcoils it can be difficult to locate small targets under the physical center of the loop. Use an "X" marks the spot technique as shown in the diagram to identify the portion of ground the nugget is in. Because most nuggets are too small to isolate to an exact location as in coin or relic hunting, remove the soil under the center of the "X" until the target is no longer in the hole, but in your pile of dirt. Techniques for examining the pile of dirt are discussed later in the manual. (page 20)

Again, the procedure is to sweep over the target from side to side noting the side to side center. Then turn 90 degrees and sweep the coil side to side noting the center from this new direction. "X" marks the spot that you need to dig. You can practice with a small pieces of lead or gold on top of the ground to become acquainted with the technique. It's a good idea to have a magnet handy, preferably in the handle of your digging pick, to pull iron out of the dirt pile. It will speed up your recovery time. It will work on small almost invisible hot rocks too.



Headphones

The headphone jack on the GMT is located on the control box near the plug for the search coil. There is a dust cover on the headphone jack that needs to be removed before the stereo plug from the headphone is inserted. Replace it when headphones are not being used. Most prospectors prefer high quality stereo headphones so White's has chosen to wire the headphone jack for stereo. If you have a mono headphone, you can purchase an adapter that will allow sound in both earpieces. Some headphones come with a switch for stereo or mono jacks.

In choosing headphones, make sure they have a **VOLUME CONTROL** as there is no target volume control on the GMT. This is an important comfort and safety issue. Remember that you want the faintest **THRESHOLD "hum"** possible but a strong comfortable target signal. With headphones you will be able to work with a lower **THRESHOLD "hum"**, hear fainter target signals, avoid bothering others with a "beeping" box, and save on battery life. Many high quality headphones from full ear enclosure to lightweight summer models that offer a bit more safety in snake and bear country are available on the market. Higher impedance headphones (60 Ohms or greater) give the most sensitivity and are better for hearing the tiny targets most likely to be heard while prospecting. Properly balanced impedance is important as well as low distortion.

Field Use & Tuning Tips

Putting it all together:

Once you have achieved the initial ground balance, you are ready to start searching. Move the coil just over the ground and listen for the distinct zip-zip sound produced by a target. It is wise to plant a nugget just under the soil to practice on in order to learn to recognize what it will sound like. If you don't have a nugget, use a nickel or piece of lead (sinker or bullet). A very shallow bird shot sounds just like a tiny piece of gold. You can practice with different sized nuggets and at different depths. Remember, planting a target disturbs the ground mineral, which usually reduces the depth it would have been found in undisturbed ground. It will take practice to determine the proper search speed and technique. Do not go too fast. Try to overlap your sweep path so that you won't miss the tiny and deeper nuggets. When you hear a zip-zip, perform the "X" pinpoint technique (page 16) over the loudest portion and eyeball the center.

Rather than concentrating on all of the controls of the detector, think of the detector's systems as an extension of your senses that are working together to tell you what is below ground. You will be tuning yourself to the search area. The GAIN, the GROUND BALANCE, the VSAT speed, the THRESHOLD, the IRON I.D., all working together at the same time. Soon the detector will not even be noticed and your senses will take over, painting a mental picture of what lies below.

Dig ALL Metal Targets at first Then Reject Iron:

At first, dig all targets until you get used to the sound of various items. As with other G.E.B. detectors, a nail or oblong piece of iron laying horizontally will produce a double beep. A "good target" is considered anything that is not IRON. You want to detect lead, brass, copper, aluminum and silver. Any of these metals can simulate the

sound of a gold nugget and must be dug. Keep a particular lookout for the tiny lead bird-shot so common in mining areas. If you are detecting these tiny targets, you are doing everything right and will eventually find gold.

Manual GROUND BALANCE tuning for very small nuggets (flakes of gold):

Instead of manual tuning for "perfect" GROUND BALANCE (no sound increase or decrease when "pumping the searchcoil up and down a few inches) you might try using the minus(-) and plus(+) touch pads to maintain a slight increase in the sound as the search coil is moved toward the ground. This will make the very tiniest nuggets (flakes of gold) visible to the detector. Here, you are trying to keep the GMT at its highest sensitivity to detect metal which might result in living with more noise from the ground mineralization. It takes experience to know what good targets sound like and the more noise you can put up with, the more sensitive you can tune the GMT, the more gold you will find. If small red "hot rocks" (positive mineralization) create problems when searching this way then return to "perfect" ground balance described above. Note, this method only applies to detecting with the Manual Ground Balance Method (-) and (+) pads.

Checking the Ground Balance (by pumping the coil up and down over the ground and listening for any threshold change) is periodically necessary during searching in the Manual Mode. Ground mineralization changes from place to place and fine tuning the Ground Balance is required for optimum performance. After a while you will automatically pump up and down a few times every so often as you prospect, noting whether you are still maintaining the slight increase in threshold as you pump the coil toward the ground, making fine adjustments by tapping the (-), or (+) buttons. In most areas, once

the detector is ground balanced, the (-) & (+) controls are used only occasionally to update the ground balance setting. Old workings and outcroppings, however, can produce large ground mineral variations that make detecting such areas a little more challenging. Fast changing ground mineralization and areas loaded with hot rocks are better searched using the Fast Auto Trac Mode of the GMT. Life will be easier and simpler.

A word about Overcorrecting when tuning for Perfect Ground Balance:

At first you will overcorrect the Ground Balance. For example, if the sound decreases as the coil approaches the ground pressing the (+) button compensates. At some point the decrease in sound as the coil approaches the ground will diminish and then the sound will shift and begin increasing as the coil approaches the ground. This overcorrection is expected and you can now switch to the (-) button to find the point little or no change in threshold is noted as the coil is pumped. You may overcorrect again with the (-) button indicated by the sound shifting back to decreasing as the coil approaches the ground and indicating you need to return to the (+) button to compensate. With practice overshooting will be minimal and by jockeying back and forth from (-) to (+) buttons you will be able to quickly hone in on perfect balance.

An OPTIONAL method for Perfect GROUND BALANCE:

Up till now we had described just one procedure for manual GROUND BALANCE. That was to determine whether the sound gets softer or louder as the coil approaches the ground. If the sound decreases as the coil approaches the ground, press the (+) button and if the sound increases as the coil approaches the ground, press the (-) button. The fact

is, whenever the sound decreases as the coil approaches the ground it will actually increase as the coil is lifted away from the ground and vice versa. Sometimes it is easier to hear an increase in sound rather than a decrease in sound. If this is easier for you, merely correct with the (+) pad if the sound increases when the coil is lifted and correct with the (-) pad when the sound increases on the down push. The end results are identical (no audio change upon either toward or away pumps of the searchcoil). Use whichever method is easiest for you.

Problems from Low Ground Mineralization:

The GMT is designed to work in an environment of heavy iron mineralization. In some instances there may be so little mineralization that the searchcoil will never go quiet as it approaches the ground or the Ground Balance pads seem to have little effect. In other words, there never seems to be any change or only a faint increase in hum as the coil is pumped, regardless of the Ground Balance setting. In this instance, merely set the number in the upper left hand corner of the display (type of ground) to "77" using the (+) & (-) touchpads.

Hot Rocks

The ever-present "hot rock" will always present problems and must be contended with. It is our belief that they should be recognized not necessarily eliminated. Most large ones are on the surface and can be kicked aside when identified. You will soon learn what they sound like. The "overshoot" or "boing" sound will soon become familiar. Fast tracking is really a good option when they are plentiful. We find it best to tune to the majority of the ground matrix and learn what a "hot rock" sounds like. The Fast Tracking of the GMT will recover quickly upon leaving the vicinity of a "hot rock" and will remain sensitive to gold nuggets. Since there are different kinds of "hot rocks", it is

Field Use & Tuning Tips

almost impossible to eliminate all of them with one setting. Some will be identified by the I.D. system as if they were iron. In every instance, practice makes perfect. As mentioned earlier, Target Analysis mode (Trigger Squeezed) can usually make negative hot rocks disappear. It uses a new method that hasn't been available before. It is easy to use and very dependable. Try it, you will like it and learn to trust it.

Negative Hot Rocks:

Negative hot rocks are ones which would balance out on Manual GROUND BALANCE by applying the (+) touchpad and run the GROUND BALANCES Numbers (type of ground) higher than the surrounding terrain. They actually produce a null or no sound when directly under the coil, making a sound once the coil passes them. This sometimes sounds like a "boing" when the ground mineral and the rock mineral are far apart in mineral TYPE, making them easy to recognize. At any rate, these are usually black or gray in color and usually magnetic. When hunting in MANUAL ground balance, they can often be tuned out by ground balancing right over them and then proceeding to search with the GMT "over tuned" to the ground. When using this procedure, be sure to search slowly and keep the coil close to the ground and level. This will eliminate the bother of such "hot rocks". Author of "Zip- Zip" Larry Sallee calls these "cold rocks". They are usually easy to identify. When using the TRIGGER SQUEEZED in the Iron Analyze Mode to check them, these Negative Hot Rocks (cold rocks) will often disappear. If the ground is littered with these negative hot rocks, not just an occasional one, the fast AUTOTRAC software will realize the negative hot rocks are a bigger problem than the matrix itself, and will track near the hot rock balance point, quieting them down a

lot. You may be forced to dial in more VSAT speed and/or reduce ground penetrating GAIN to keep a workable THRESHOLD "hum".

Positive Hot Rocks and Alkalai:

They are usually red or various shades of red to almost black. They ground balance with the (-) touch pad. They are sometimes as small as BB's and sound just like nuggets. These positive "hot rocks" are almost impossible to tune out and can tune at very low numbers on the LCD display meter, near salt. They actually give a positive signal like metal and that is why they are so hard to differentiate. Reducing the GAIN and tuning with a neutral or slight reduction in sound on the down stroke of the coil during ground balancing can soften their sound and help to make them less visible. The Twin D coil on the GMT also helps in eliminating these pests. Wet alkalai washes can be extremely difficult to work due to the sensitivity of high frequency gold detectors to conductive dissolved salts and their similarities with the responses of small gold.

Adjusting GAIN with FAST AUTOTRACK:

If while searching with FAST AUTRACK you experience erratic behavior such as false signals or constant beeping and popping, you may be using a GAIN level which is too high for the ground mineralization. Merely reduce the GAIN by turning the Gain control a notch counter clockwise. Try searching again. Continue this until you can hunt without having erratic signals. Your detector is cancelling ground mineral as you sweep, so you may notice a slight fluctuation in the threshold hum as the various ground minerals are tracked out. Adjusting GAIN in Manual GROUND BALANCE is done in the same fashion.

Pinpointing or "X" ing the target:

In most cases, pinpointing is easily performed by merely "X-ing" or crisscrossing. The loudest part of the target will be under the center of the coil, just as with any detector. After the approximate location of the target is determined, take a handful of soil and check the hole again. Continue this process until the target is no longer in the hole, but in the hand. Try putting the handful of soil in a plastic container (pan, tray, cup, or scoop). Passing the container over the coil will determine if the target is really in it. If so, a series of separations will quickly expose the nugget.

Handful Of Dirt:

Some prefer to pass the handful of dirt across the coil directly. Caution must be exercised if this is done. The GMT is sensitive enough to pick up the salt in your hand and respond with a signal. Try this with nothing in your hand and you will see how close you can come to the coil using this method. One way around this salt sensitivity is to pinch the soil in small amounts and wave only the fingers over the searchcoil. You will find the way best suited to your needs. The condition of the soil - dry, wet, fine, coarse, etc. will have a lot to do with the best method for you.

GAIN and VARIABLE SAT (Self Adjusting Threshold) Speed:

The (-) and (+) Ground Balance pads compensate for common ground minerals in the area. The V-SAT control compensates for the consistency of that ground mineralization. The greater the degree of inconsistencies, the more SAT is needed to quiet ground noise. If the THRESHOLD becomes too erratic or noisy, it might be necessary to use the V-SAT feature and/or reduce the GAIN control. This

noisy behavior will make it difficult to recognize a true target (possible nugget) from pieces of mineral, commonly referred to as "hot rocks". It is not wise to keep a high level of GAIN if the detector will not operate smoothly. This is a false sense of security. Recognizing a true target is the most important part of detecting. This is an example of when less GAIN will produce more nuggets. You must be the best judge of just how much noise you can tolerate and still identify nuggets, as well as the combination of V-SAT and GAIN which produces the desired results in your area. Therefore, if you have been operating your GMT at the full level of GAIN (10) and you determine that this is too high because either the threshold is erratic or the detector is giving false signals; always begin by reducing the GAIN toward the Initial Setting triangle of (7 to 8). If this does not correct the problem, start adding some SAT speed by turning the SAT control slowly clockwise. If this does not correct the problem, go back to the GAIN and reduce it a little more and add a bit of SAT. As I mentioned earlier it is sort of like seasoning a pot of soup. Some salt and some pepper. Remember any drop in GAIN below (7-8) will result in some loss of depth. Any increase in SAT speed above the Initial Setting of (3-4) will also reduce overall depth. However, every ground condition has its optimum setting. Overall depth is not the ultimate goal. Finding nuggets is! Unless your threshold is constant and as smooth as possible, and free from false targets which confuse the picture, you will never be able to tell the ground from the gold. We like to use the analogy of driving on a straight road versus a curvy road. The object is to get from point A to point B. 65 mph might get you there on a straight road, but you will have to slow to 35 mph if the road is curvy, or you will end up off the road. The straight road is like low mineralized ground and the curvy road is like heavy

Field Use & Tuning Tips

mineralization. High Gain and slower SAT will not get you the Gold in heavy mineralization as well as lower GAIN and a bit of faster SAT.

Overload:

The GMT can most always tell the difference between overload from a large metal target and extreme mineralization or hot rock. Under some unusual situations, it can seem confused and give a mixed opinion. Whichever the case, raising the search coil is the first solution. If the target is a large or surface piece of metal it will cease to overload quickly and you can investigate by digging it up. Lowering the GAIN will usually cure a mineralized area, but will not do much to eliminate a real target. With a little practice you will figure it out. If the overload seems everywhere it is probably mineralization and lowering GAIN is essential.

Iron Probability:

Internally, the GMT has two independent and slightly different Iron Probability Systems; one for audio tone (grunt) and the other for the visual display. The tone and the visual ID System will usually agree, but once in a while they may disagree. If the tone and the visual display disagree, the visual will usually be more accurate, especially if you use the "Target Analysis trigger.

Misclassifying Iron:

The Iron Probability System will consistently identify some types of Iron and Steel objects as non-ferrous, particularly flat thin steel such as a can lid, very large pieces of iron, and small solid pieces of iron like heavy washers. Because this is a gold detector, it was essential to design it so that it would tend to call doubtful targets "non-ferrous" or "possible gold". In this way, eliminating the possibility of mistaking gold for iron.

% Iron Probability Blocking:

In operating the GMT, we have noticed that the % of Iron Probability Block Graph is very dependable. We noted that when the blocking hesitated to go above 75% on the probability scale it was most always non-ferrous. On our field testing, the first small piece of gold we dug registered at 75% and stayed there. It was a 3 grain piece. We dug dozens of small bird shot which reacted the same way. We also found that the blocking could be "pushed up the scale" past 75% to the point of "grunting" by continued sweeps over the target with the trigger squeezed (target analyzer). However, we also found that if we pushed repeatedly, in some instance, we were able to push a bird shot into the "grunt" zone. We ultimately were able to predict if the target was ferrous or non-ferrous by how hard we had to "work it" to get it to go full scale or "grunt". It will take some practice, but we found it very reliable. We soon had confidence in it. The larger pieces of non-ferrous such as lead bullets and a "lonely ever present pull tab" registered well below the 50% Iron Probability range and gave our hearts the usual jolt. You must always remember that a 75% probability of Iron is also a 25% probability chance of gold (non-ferrous). That is why we have set the "Iron Grunt" at 85%. or more. Below that, you should investigate.

Overload Message:

It will be noted that the overload messages "BAD GROUND REDUCE GAIN" or " METAL TOO CLOSE LIFT SEARCH COIL" only appear in the display at that moment when the search coil is over the overloading ground or metal target.

If you are overloading over a metal target and you stop the coil over it, the overload "squawk" and message will continue. When you raise the search

coil till the message and "squawk" stop, you can decide how large the target is and whether you wish to dig it up to investigate. If you get the message that the overload is from "Bad Ground", again the audio and visual indication will be only momentary, while your search coil is over the area which is overloading the unit. If the indication is only brief, you should probably just continue on searching. If however, the message of Bad Ground repeats itself frequently, you should probably heed the warning and REDUCE GAIN.

VSAT Tricks :

Prior Goldmaster models did VSAT electrically. The GMT is computerized, which gave White's the opportunity to improve VSAT in ways which weren't practical in the past. These improvements "kick in" progressively at settings higher than 6, allowing better ground silencing in highly variable ground. At these higher settings, negative hot rocks will sound "different" giving a "double blip" sound or vanishing entirely, rather than giving the "boing" sound you will get at lower settings.

Another difference between a gold nugget and a negative hot rock is that when you sweep back and forth, the gold nugget will "stay in one spot" but the negative hot rock will seem to keep wandering around. This can also be the case with a pocket of negative mineralization.

The more you use the GMT, the more you will come to appreciate the very fast tracking which allows you to work with little effort in the changing ground mineralization where most gold is found and also to appreciate the ability to eliminate much iron trash without sacrificing depth or gold.

Information

Proper care

I. Cleaning

A. Both the coil and rod are waterproof and can be cleaned with fresh water and mild soap. The control box is not waterproof and must be kept dry. **Never** lift a wet coil above the height of the control box as water can run down the inside of the rod damaging the electronics. A damp cotton cloth can be used to wipe off a dirty control box.

II. Weather

- A. Do not expose your detector to the conditions of a car trunk during winter and/or summer extremes.
- B. Protect it from direct sunlight during storage.
- C. The control box is rain resistant. However, it must be protected from heavy rain.

III. Storage

- A. When the instrument is not in use, make sure it is turned OFF.
- B. If you plan on storing your detector for long, remove the battery holder from the instrument and remove the batteries from the holder.
- C. Store the instrument indoors, in an area where it will be protected from abuse. Over the years White's has noted more service repairs and physical damage, on units in storage than those experiencing daily use.

IV. Additional Precautions

- A. Avoid dropping your detector while attempting to set it down to dig.
- B. Avoid using your detector for leverage when standing up from a dig.
- C. Do not use any lubricants, such as WD-40, on any part of your detector.
- D. Do not modify your instrument during its warranty period.

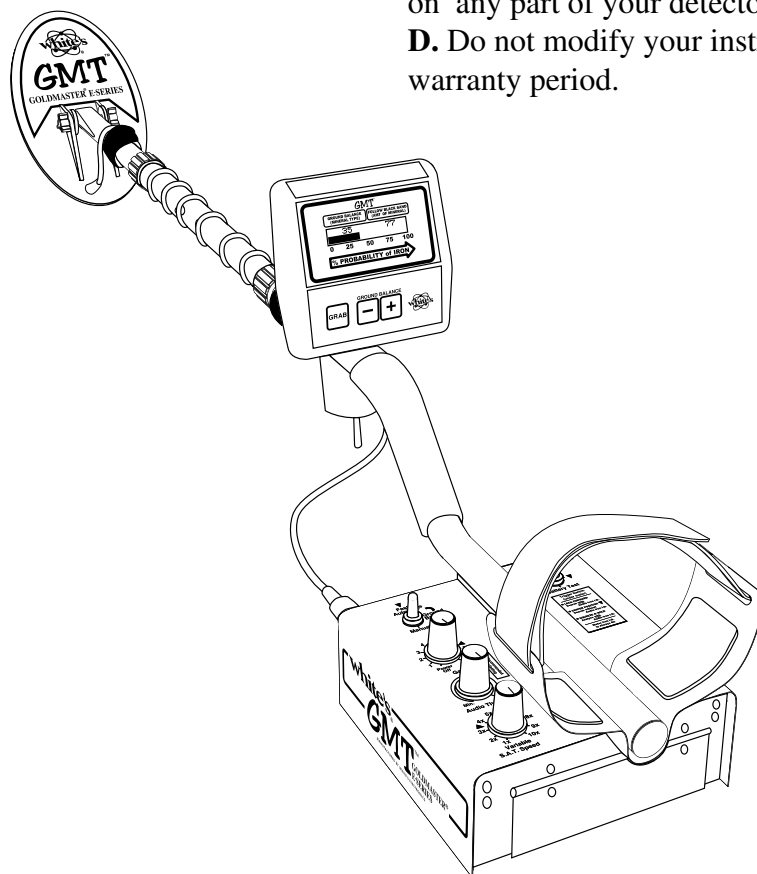

Service

White's reputation has been built on quality products backed by quality service. Our Factory Authorized Service Centers are factory trained and equipped. They offer the same quality service as the factory. Service before and after the sale is the cornerstone of our customer relations.

White's Authorized USA Service Centers:

Centerville Electronics
13810 B Braddock Road
Centerville, Virginia 20121
Toll Free 1-888-645-0202
Fax: 1-703-222-8625
E-Mail: centelec@vwx.com

Geoquest
106 US Hwy. 46
Saddle Brook, New Jersey 07662
Toll Free: 1-877-772-7443
Fax: 1-973-772-7773
E-Mail: geoquest@erols.com

Electronic Exploration
700 South Main
Lombard, Illinois 60148
Toll Free: 1-800-392-3223
Fax: 1-630-620-1005
E-Mail: akempf@mediaone.net

White's Electronics, Inc.
1011 Pleasant Valley Road
Sweet Home, Oregon 97386
Telephone: 1-541-367-6121
Fax: 1-541-367-6629
E-Mail: wmckillop@whitesmetaldetectors.com

Before shipping detectors for service:

- A.** Contact your Dealer. There may be a quick, simple fix or explanation that will prevent having to send the detector in for service.
- B.** Double check the obvious, such as batteries, and try the detector in another area to be sure there is not interference.
- C.** Be sure to send all necessary parts with your detector, such as search-coil, batteries and holders, as these items can result in symptoms.
- D.** Always include a letter of explanation about your concerns, even if you have talked to the Service Center by telephone.
- E.** Take care in packaging instruments for shipping and always insure your package.

Warranty

If within two years (24 months) from the original date of purchase, your White's detector fails due to defects in either material or workmanship, White's will repair or replace at its option, all necessary parts without charge for parts or labor.

Simply return the complete detector to the Dealer where you purchased it, or to your nearest Authorized Service Center. The unit must be accompanied by a detailed explanation of the symptoms of the failure. You must provide proof of date-of-purchase before the unit is serviced.

This is a transferable manufacturer warranty, which covers the instrument two years from the original purchase date, regardless of the owner.

Items excluded from the warranty are non-rechargeable batteries, accessories that are not standard equipment, shipping / handling costs outside the continental USA, Special Delivery costs (Air Freight, Next Day, 2nd Day, Packaging Services, etc.) and all shipping / handling costs inside the continental USA 90 days after purchase.

White's registers your purchase only if the Sales Registration Card is filled out and returned to the factory address by your dealer, soon after original purchase for the purpose of recording this information, and keeping you up-to-date regarding White's ongoing research & development.

The warranty does not cover damage caused by accident, misuse, neglect, alterations, modifications, unauthorized service, or prolonged exposure to corrosive compounds, including salt.

Duration of any implied warranty (e.g., merchantability and fitness for a particular purpose) shall not be longer than the stated warranty. Neither the manufacturer or the retailer shall be liable for any incidental or consequential damages. Some states however, do not allow the limitation on the length of implied warranties, or the exclusion of incidental or consequential damages. Therefore, the above limitations may not apply to you.

In addition, the stated warranty gives you specific legal rights, and you may have other rights which vary from state-to-state.

The foregoing is the only warranty provided by White's as the manufacturer of your metal detector. Any "extended warranty" period beyond two years, which may be provided by a Dealer or other third party on your detector, may be without White's authority involvement and consent, and might not be honored by White's Electronics, Inc.

Warranty Transfer

If for any reason you should sell your GMT prior to the date the warranty expires, the remaining warranty is transferable. **This transfer is authorized by calling 1-800-547-6911, and getting an Authorization Number.**

Simply fill out the following information, including the Authorization Number, seal it in a stamped envelope, and send it to **White's Electronics, 1011 Pleasant Valley Road, Sweet Home, Oregon 97386.** The remaining warranty period will then be available to the new owner.

The Warranty Statement applies to both the original owner as well as the second owner.



 **WARRANTY TRANSFER**

Original Owner:

Name: _____

Address (Which appears on the original warranty card):

Instrument Serial Number: _____

Original Purchase Date: _____

New Owner:

Name: _____

Address: _____

Comments: _____

Distributor Authorization Code: _____

Video

A Video cassette detailing the proper use of the Goldmaster GMT will be available soon. This video explains how to use the GMT in the field, as well as explaining the many varied options. Intended for English speaking persons, it is recorded on VHS format.

White's recommends the this video cassette as a valuable learning aid for both beginners, and experienced metal detector users. For more information, please contact your Dealer.

Owner Information

Serial Number: _____ (*inside of battery compartment*)

Purchase Date: _____ (*The date on the sales receipt*)

Dealer Name: _____

Address: _____

Telephone #: _____

Payment method: _____

Personal markings: _____
